

INSTALLATION INSTRUCTIONS



CORKSPORT **Port Injection Fuel Kit**

2007-2013 Mazdaspeed 3

PART #: AXL-6-912-10

Need Help With Your Installation? Call (360)260-CORK



*We absolutely, positively,
deliver - every time.*

CORKSPORT.COM



CORKSPORT Port Injection Fuel Kit

2007-2013 Mazdaspeed 3

PRODUCT DESCRIPTION:

Go beyond the limitations of the OEM fuel system and have big power potential on your MS3 with the CorkSport Port Injection Fuel Kit! Each kit sets up a full standalone fuel system on your speed with its own fuel cell, pump, injectors, filters, lines, and all the miscellaneous fittings required for install. All you need is a port injection ready manifold, fuel rail, and to setup the wiring for all components. You can bundle a Split Second Injector Controller and Injector Dynamics 1050x injectors for a complete and ready to use kit.

Please let us know your feedback of the CS Aux Fuel Kit by submitting a review at: <https://corksport.com/mazdaspeed-3-8th-port-auxiliary-fuel-kit.html>

PRE-INSTALLATION NOTES:



Verify that your vehicle is completely cooled down prior to starting installation. If you are going to work on your car within an hour or two of driving it, use a fan to cool off the car.



These instructions were written for reference only and the use of a factory service manual is recommended. Most of the installation images shown on 2013 Mazdaspeed 3. Earlier MS3 will be similar.



Due to the location of the CorkSport Auxiliary Fuel Tank, most oil catch can setups will need to be relocated away from the driver's side frame rail.



Some minor drilling is required for installation.



Failure to follow correct bolt lengths stated in instructions can result in tank damage.



Off-Road/Racing Use Only. Owner assumes all risk when installing this fuel kit.



We strongly encourage a "wire tucked" wiring harness for ease of installation.



Electrical routing and connections are required for operation.

MATERIALS & TIME:

GENERAL INFO:



Time Est:
6+hr



Difficulty:
5/5



CEL:
No



Warranty:
2-Year





TOOLING LIST:

- 8mm Socket
- 10mm Socket
- 12mm Socket
- 13mm Socket
- 3/8" Drive Ratchet
- 3" Extension
- 6" Extension
- 8mm Wrench
- 10mm Wrench
- 11mm Wrench
- 1/2" or 13mm Wrench
- 7/16" Wrench
- 5/8" Wrench
- 11/16" Wrench
- 15/16" Wrench
- 1" Wrench
- 1 1/16" Wrench
- Adjustable Wrench
- 2mm Allen Wrench
- 5mm Allen Wrench
- 6mm Allen Wrench
- 1/8" Allen Wrench
- Phillips Screwdriver
- Flathead Screwdriver
- Jack Stands
- Floor Jack
- Wire & Wiring Supplies
- Cordless Drill
- 1/4" Drill Bit
- Fuel & Oil Safe PTFE Thread Tape or Sealant

PARTS LIST:

- One (1) CorkSport Auxiliary Fuel Tank
- One (1) CorkSport Auxiliary Fuel Tank Hardware Kit
- One (1) CorkSport PI Hardware & Fittings Kit
- One (1) AEM Fuel Pressure Regulator
- One (1) Fuelab Fuel Pressure Gauge
- One (1) Quantum 380LPH Fuel Pump
- One (1) "044" Style Fuel Pump Bracket
- One (1) DeatschWerks Pre-Pump Filter
- One (1) DeatschWerks Post-Pump Filter
- One (1) CorkSport PI Kit Fuel Line 1
- One (1) CorkSport PI Kit Fuel Line 2
- One (1) CorkSport PI Kit Fuel Line 3

ORDER OF OPERATIONS & TABLE OF CONTENTS:

	VEHICLE DISASSEMBLY & PREPARATION	
	Section 1: 2007-2009 Mazdaspeed 3 Removing OEM Front Bumper & Headlight	Pg. 4-7
	Section 2: 2010-2013 Mazdaspeed 3 Removing OEM Front Bumper & Headlight	Pg. 8-11
	Section 3: 2007-2009 Mazdaspeed 3 Installation Preparation	Pg. 12-14
	Section 4: 2010-2013 Mazdaspeed 3 Installation Preparation	Pg. 15
	CORKSPORT AUXILIARY FUEL TANK INSTALLATION & SETUP	
	Section 5: CorkSport Auxiliary Fuel Tank Installation	Pg. 16-20
	Section 6: CorkSport Auxiliary Fuel Tank Setup	Pg. 20-21
	CORKSPORT PORT INJECTION FUEL KIT INSTALLATION	
	Section 7: Preparing for Port Injection Installation	Pg. 22-25
	Section 8: Fuel Rail Setup	Pg. 26-28
	Section 9: Fuel Filter Setup	Pg. 28-31
	Section 10: Fuel Pump Setup & Installation	Pg. 31-35
	Section 11: Post Pump Fuel Filter Installation	Pg. 36-38
	Section 12: Fuel Line Installation	Pg. 39-43
	Section 13: Fuel Line Isolation	Pg. 44-47
	WIRING SETUP & INSTALLATION	
	Section 14: Injector & Split Second Wiring Setup	Pg. 47-48
	Section 15: Fuel Pump & Misc. Wiring Setup	Pg. 49-52
	VEHICLE REASSEMBLY & TESTING	
	Section 16: Final Setup & Testing	Pg. 53-54

DETAILED INSTRUCTIONS:

1. 2007-2009 Mazdaspeed 3 Removing OEM Front Bumper & Headlight

NOTE

2010-2013 Mazdaspeed 3 owners skip to Section 2 on page 8.

- a) Use a floor jack and jack stands to gain access to the underside of the vehicle. You will need to access to the engine bay and the underside of the car.
- b) Lift up the hood and remove four Phillips head push clips from the inlet ducts. Shown **circled in red** in **Figure 1a**.
- c) Remove two Phillips head screws from the top of the grill. Shown **circled in blue** in **Figure 1a**.
- d) Remove two push clips from near the headlights. Shown **circled in green** in **Figure 1a**.

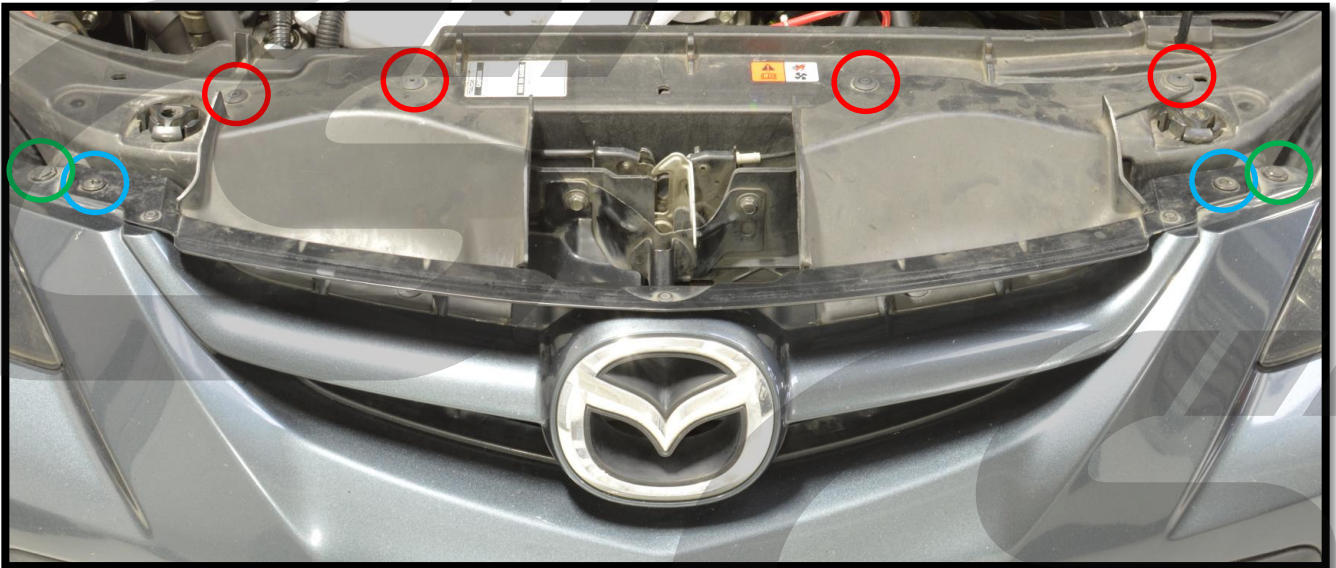

Figure 1a

DETAILED INSTRUCTIONS:**1. 2007-2009 Mazdaspeed 3 Removing OEM Front Bumper & Headlight (cont.)**

- e) Remove three 10mm bolts from the OEM splash shield using a 10mm socket and ratchet. Shown **circled in red** in **Figure 1b**.
- f) Remove three push clips from the OEM splash shield using a flat head screwdriver or push clip removal tool.. Shown **circled in blue** in **Figure 1b**. The center push clip is hidden underneath the rear section of the splash shield but is still shown below.
- g) Remove five 8mm bolts from the front section of the OEM splash shield using an 8mm socket & ratchet or Phillips screwdriver. Shown **circled in green** in **Figure 1b**.
- h) The front section of the OEM splash shield can then be removed and set out of the way.

**Figure 1b**

- i) Using an 8mm socket or Philips screwdriver, remove three (3) screws from each side of the vehicle that attach the inner fender liner to the front bumper. **Circled in red** in **Figure 1c**.

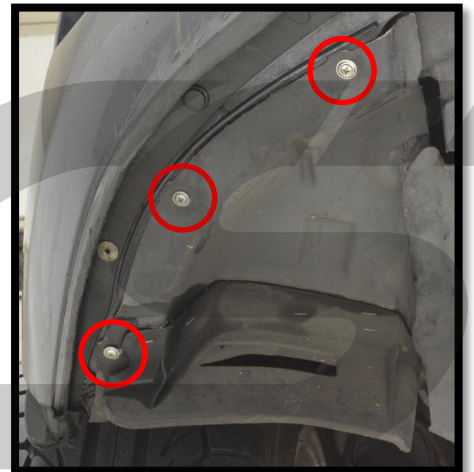
**Figure 1c**

DETAILED INSTRUCTIONS:**1. 2007-2009 Mazdaspeed 3 Removing OEM Front Bumper & Headlight (cont.)**

j) Unplug the wiring harness from each fog light and unclip the wiring from the bumper. **Circled in red** in **Figure 1d**.

k) Remove the Philips head screw from the air temperature sensor bracket. Unclip the wiring harness from the bumper and position out of the way. Wiring shown **circled in red** in **Figure 1e**.

l) Remove two (2) Philips head push clips from each side of the inner fender liner. Shown **circled in red** in **Figure 1f**.

m) Gently pull the inner fender liner to locate and remove one (1) 8mm/Phillips head screw from each side. The screw is located where the bumper connects to the front fender. Pull in the direction shown with the **blue arrow** in **Figure 1f**. The location is **circled in blue** in **Figure 1f**.

n) Remove the bumper from the vehicle.

- Gently pull on the sides of the bumper to release it from the clips located around the headlights and fenders.
- Pull up and out on the middle of the bumper to release the two (2) clips. If they will not release, they can be accessed from behind the grill.



Apply some blue painters tape to the fender and headlight near the bumper to prevent damage to the paint.

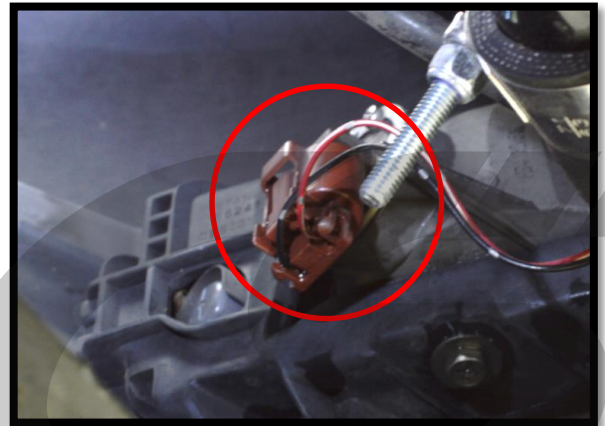

Set the bumper on a soft towel or large piece of cardboard to avoid damaging the paint.

**Figure 1d****Figure 1e****Figure 1f**

DETAILED INSTRUCTIONS:

1. 2007-2009 Mazdaspeed 3 Removing OEM Front Bumper & Headlight (cont.)

- o) Remove one Phillips head push clip from the corner of the driver's side headlight. Shown **circled in red** in **Figure 1g**.
- p) Remove three 10mm bolts from the headlight. Shown **circled in blue** in **Figure 1g**.

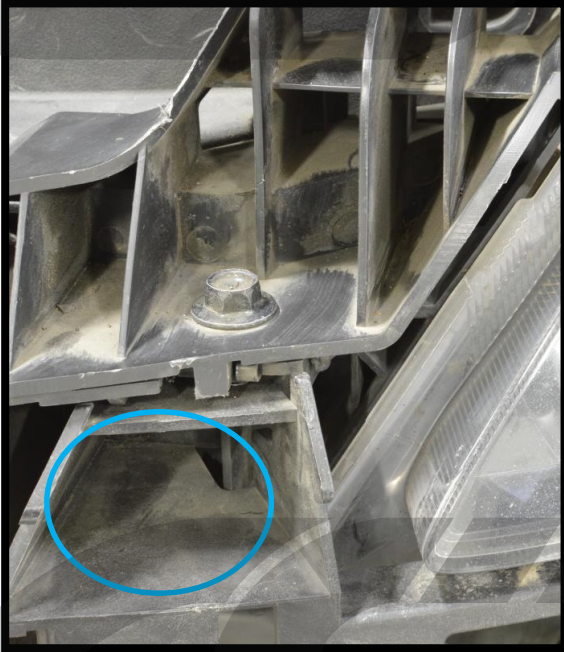

Figure 1g

- q) Gently pull on the headlight to release it from its mounting. Then, remove the four (4) electrical connectors from the backside of the headlight. Shown **circled in red** in **Figure 1h**. It will now be free to remove from the vehicle.

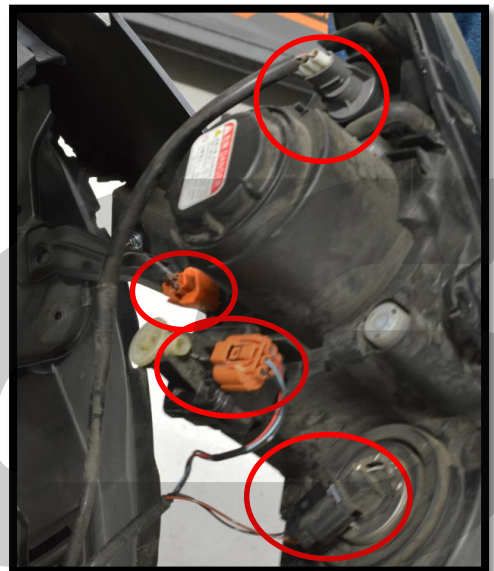

Figure 1h

DETAILED INSTRUCTIONS:

2. 2010-2013 Mazdaspeed 3 Removing OEM Front Bumper & Headlight

NOTE

2007-2009 Mazdaspeed 3 owners skip to Section 3 on page 12.

- a) Use a floor jack and jack stands to gain access to the underside of the vehicle. You will need to access to the engine bay and the underside of the car.
- b) Lift up the hood and remove six push clips from the top of the front bumper. Shown **circled in red** in **Figure 2a**.
- c) Remove two Phillips head screws from the top of the front bumper. Shown **circled in blue** in **Figure 2a**.

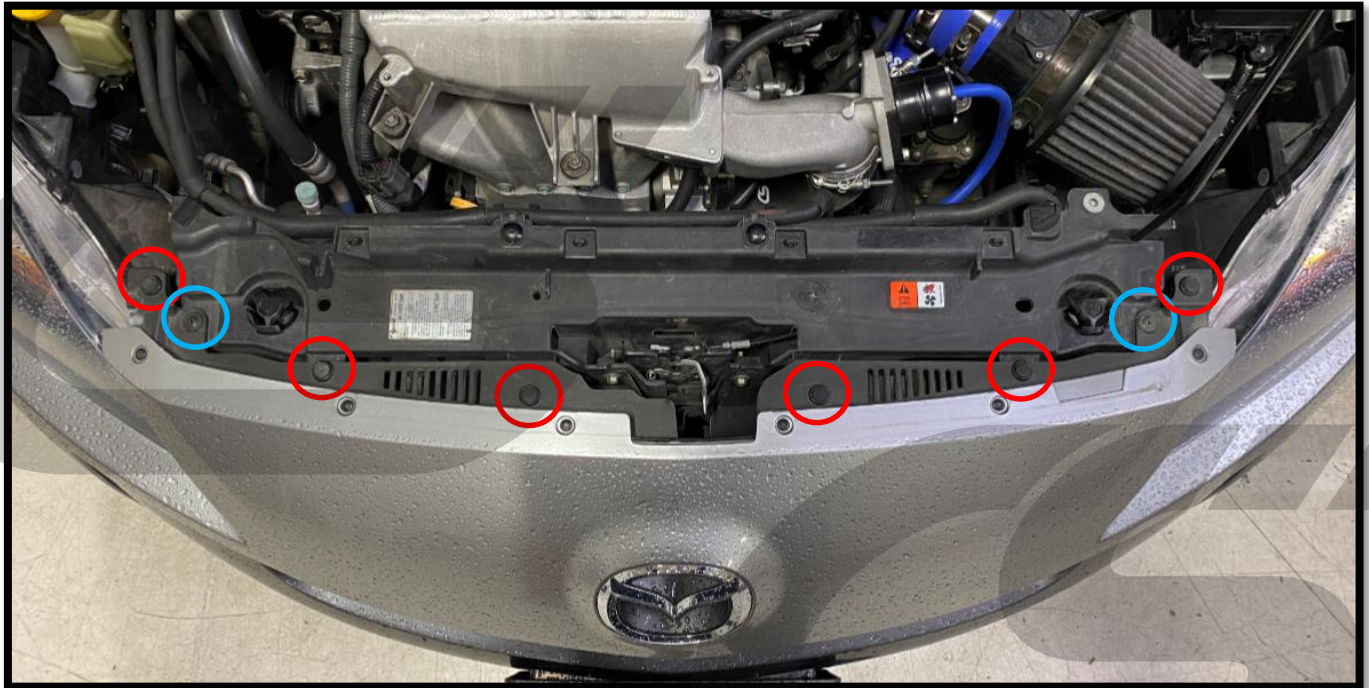
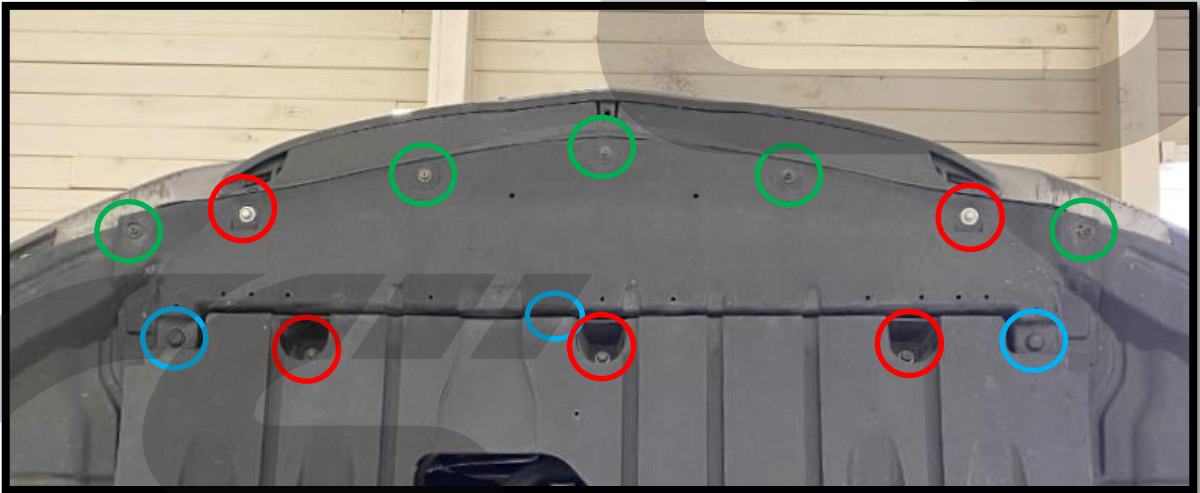

Figure 1a

DETAILED INSTRUCTIONS:**2. 2010-2013 Mazdaspeed 3 Removing OEM Front Bumper & Headlight (cont.)**

- d) Remove five 10mm bolts from the OEM splash shield using a 10mm socket and ratchet. Shown **circled in red** in **Figure 2b**.
- e) Remove three push clips from the OEM splash shield using a flat head screwdriver or push clip removal tool.. Shown **circled in blue** in **Figure 2b**. The center push clip is hidden underneath the rear section of the splash shield but is still shown below.
- f) Remove five 8mm bolts from the front section of the OEM splash shield using an 8mm socket & ratchet or Phillips screwdriver. Shown **circled in green** in **Figure 2b**.
- g) The front section of the OEM splash shield can then be removed and set out of the way.

**Figure 2b**

- h) Using an 8mm socket or Philips screwdriver, remove two screws from **each side** of the vehicle that attach the inner fender liner to the front bumper. **Circled in red** in **Figure 2c**.

**Figure 2c**

DETAILED INSTRUCTIONS:

2. 2010-2013 Mazdaspeed 3 Removing OEM Front Bumper & Headlight (cont.)

- i) Disconnect the fog light wires and remove wiring from the bumper. Disconnect the fog light connectors and use a small flat head screwdriver to disengage the clips that hold the wiring to the bumper. Shown with the **red circles** in **Figure 2d and 2f**.
- j) Follow the wire across the vehicle and disconnect it from the retaining clips that hold it to the bumper. Shown with **red circles** in **Figure 2e**.

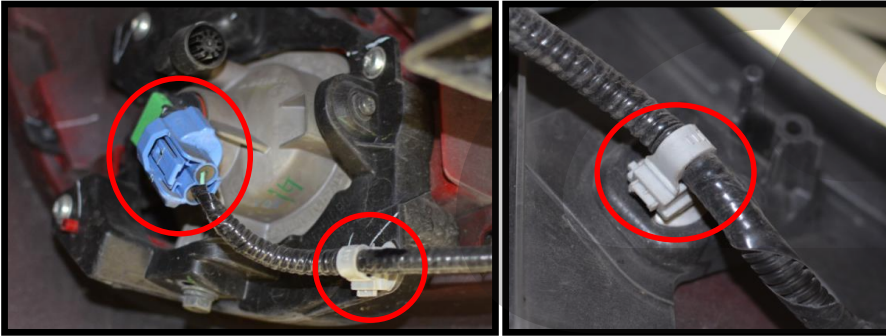

Figure 2d: Driver's Side



Figure 2e: Center

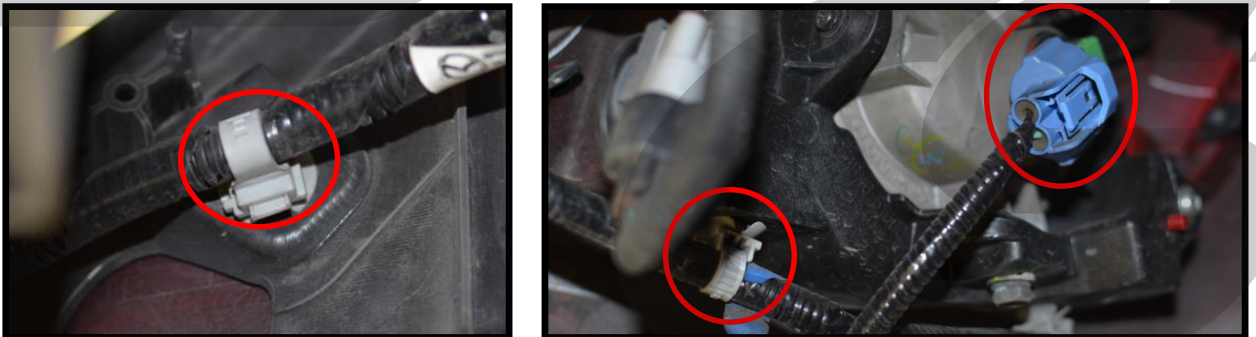

Figure 2f: Passenger's Side

DETAILED INSTRUCTIONS:**2. 2010-2013 Mazdaspeed 3 Removing OEM Front Bumper & Headlight (cont.)**

j) Remove three push clips from each side of the inner fender liner. Shown **circled in red** in **Figure 2g**.

k) Remove one 8mm/Phillips head screw from each side. Shown **circled in blue** in **Figure 2g**.

l) Remove the bumper from the vehicle.

- Gently pull on the sides of the bumper to release it from the clips located around the headlights and fenders.
- Pull up and out on the middle of the bumper to release the two (2) clips.

NOTE Apply some blue painters tape to the fender and headlight near the bumper to prevent damage to the paint.

NOTE Set the bumper on a soft towel or large piece of cardboard to avoid damaging the paint.

m) Remove one Phillips head push clip from the corner of the driver's side headlight. Shown with **red arrow** in **Figure 2h**.

n) Remove three 10mm bolts from the headlight. Shown **in blue** in **Figure 2h**.

o) Disconnect the electrical connector for the headlight. Shown **circled in green** in **Figure 2h**.

p) The headlight can now be removed from the vehicle.

**Figure 2g****Figure 2h**

DETAILED INSTRUCTIONS:

3. 2007-2009 Mazdaspeed 3 Installation Preparation

NOTE 2010-2013 Mazdaspeed 3 owners skip to Section 4 on page 15.

NOTE If you have an OCC mounting in the location shown in Figure 3a, you will need to relocate it at this time.

- a) Remove one 10mm bolt from the bottom of the frame rail. Shown removed and **circled in red** in **Figure 3a**.
- b) Install the supplied lower side bracket as shown in **Figure 3b** with one of the supplied M6x1.0x16mm bolts. Ensure the bracket is in the orientation shown and the bolt is all the way to the end of the slot as shown.

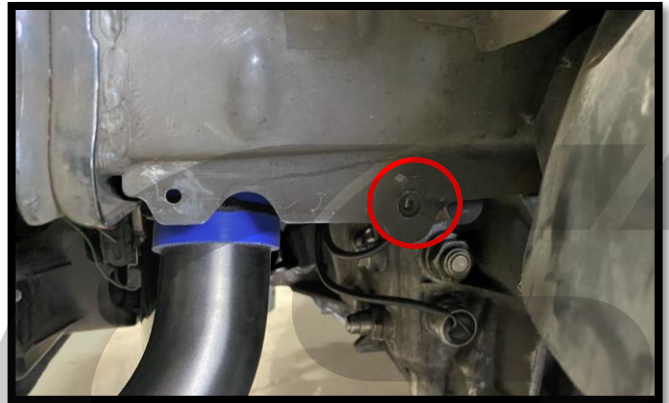

Figure 3a



Figure 3b

- c) Using the bracket as your guide, mark a position to drill an additional hole for mounting. The hole should be near the end of the other slot as shown. You can also use the "dimple" present in the stamping of the frame rail. Your hole position should be slightly above and forward of the "dimple". The "dimple" can be seen in **Figure 3b** with the **green arrow**.
- d) Once confident with hole position, drill a hole through the bottom of the frame rail with a 1/4" drill bit. Shown completed in **Figure 3b** with **blue arrow**.

NOTE If you had an OCC mounted in the location shown, this hole may already be present and may be able to be used. Verify correct location of the hole using the supplied bracket and Figure 3b above.

DETAILED INSTRUCTIONS:**3. 2007-2009 Mazdaspeed 3 Installation Preparation (cont.)**

- e) Loosely install the lower side bracket using another supplied M6x1.0x16mm bolt and M6 nut as shown in **Figure 3c**.
- f) Repeat the hole drilling process for the top side of the frame rail. There is another “dimple” in this location. Again, your hole needs to be slightly above and slightly forward of this dimple. See **Figure 3c** for location **circled in red**. Once satisfied that the location matches **Figure 3c**, drill a hole with a 1/4" drill bit.

 Ensure there is nothing behind this portion of the frame rail prior to drilling. There is a wiring harness close that we recommend you temporarily move out of the way for drilling to prevent any damage.

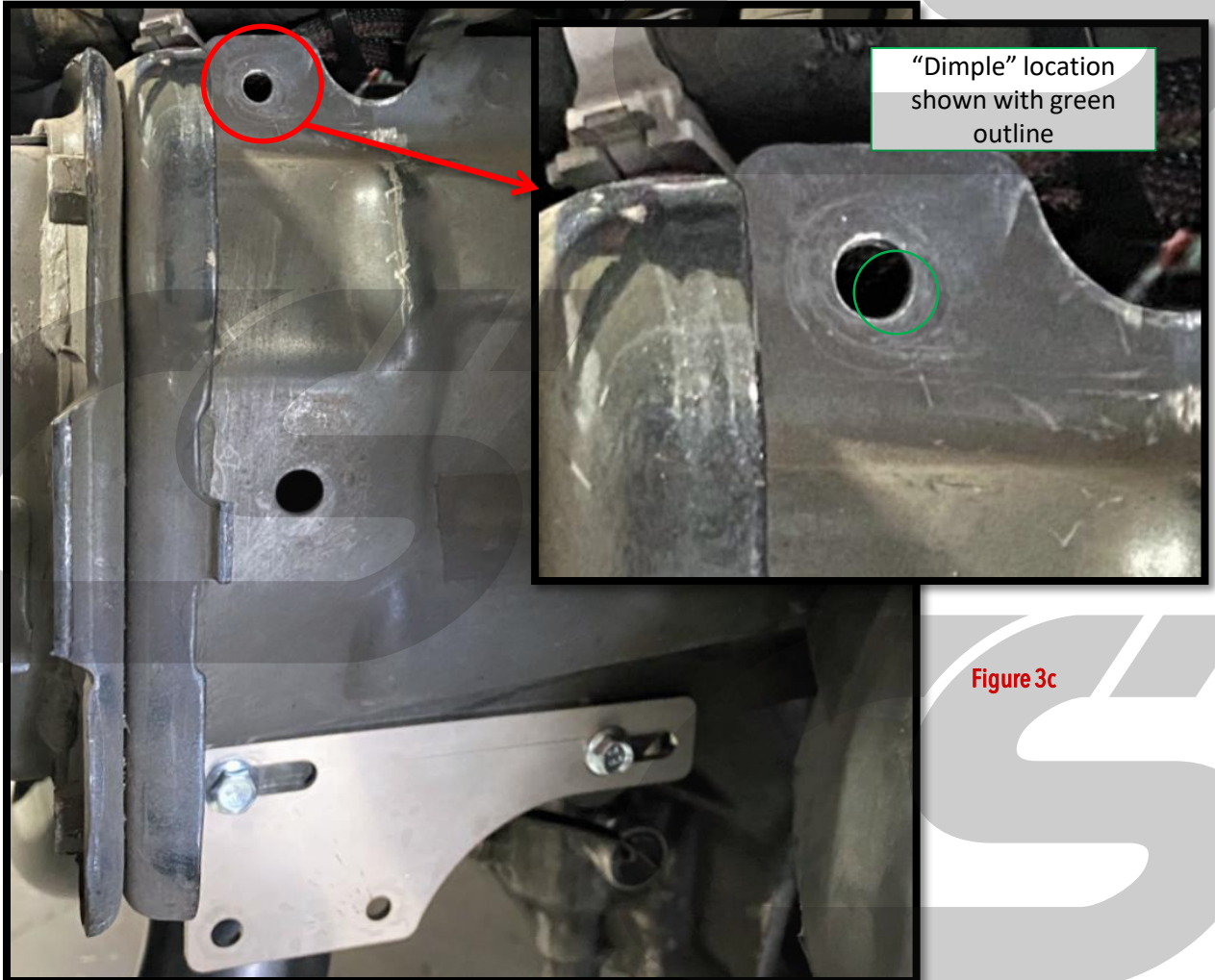
**Figure 3c**

DETAILED INSTRUCTIONS:

3. 2007-2009 Mazdaspeed 3 Installation Preparation (cont.)

- g) Locate the two ground wires attached to the fender support arm. Remove the 10mm bolt from each ground wire. Bolts **circled in red** in **Figure 3d**.

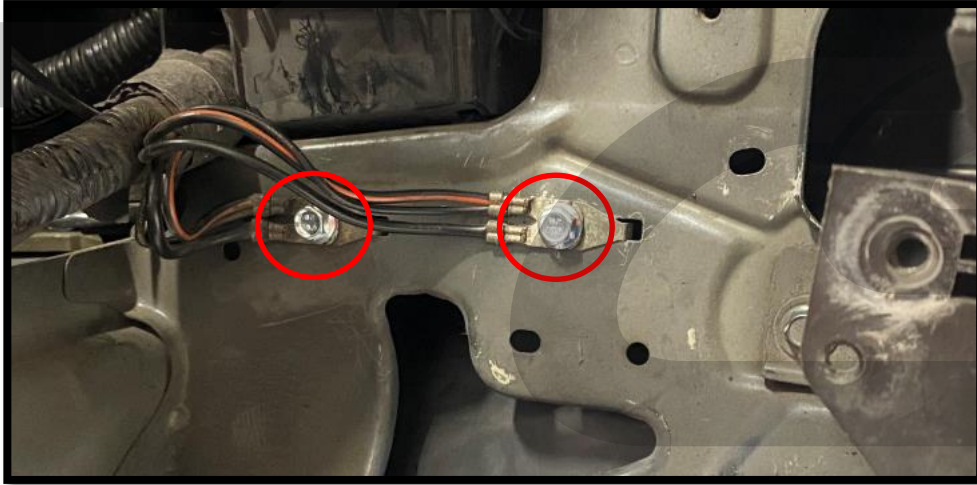

Figure 3d

- h) Flip the right side ground wire over and line it up with the other ground wire hole as shown in **Figure 3e**.
- i) Secure both ground wires in the left side hole with one of the 10mm bolts removed earlier as shown in **Figure 3e**.

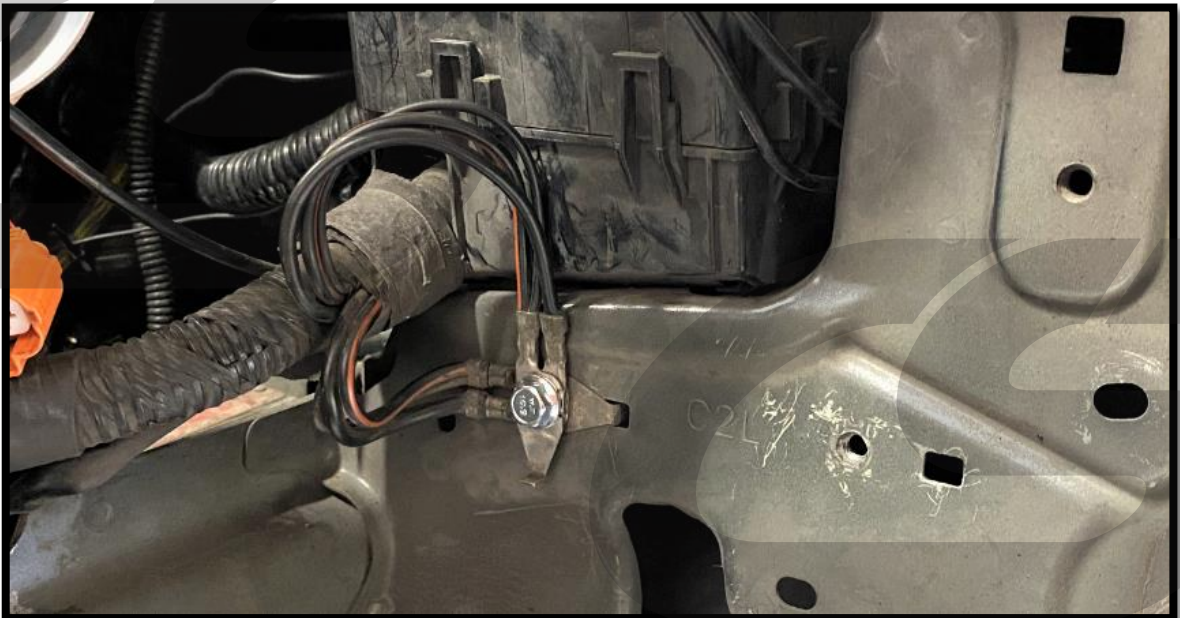

Figure 3e

DETAILED INSTRUCTIONS:

4. 2010-2013 Mazdaspeed 3 Installation Preparation

NOTE 2007-2009 Mazdaspeed 3 owners skip to Section 5 on page 16.

NOTE If you have an OCC mounting in the location shown in Figure 4a, you will need to relocate it at this time.

- Remove two 10mm bolts from the frame rail. Shown **circled in red** in **Figure 4a**.
- Unclip the wiring harness from its mounting point on the frame rail. Location of wiring harness clip **circled in blue** in **Figure 4a**.
- Install the supplied lower side bracket as shown in **Figure 4b** with two of the supplied M6x1.0x16mm bolts. Ensure the bracket is in the orientation shown and the bolts are approximately $\frac{3}{4}$ " of the way to the rear of the slot as shown (the end of the slot should be visible past the bolt). Leave these bolts loose for now.

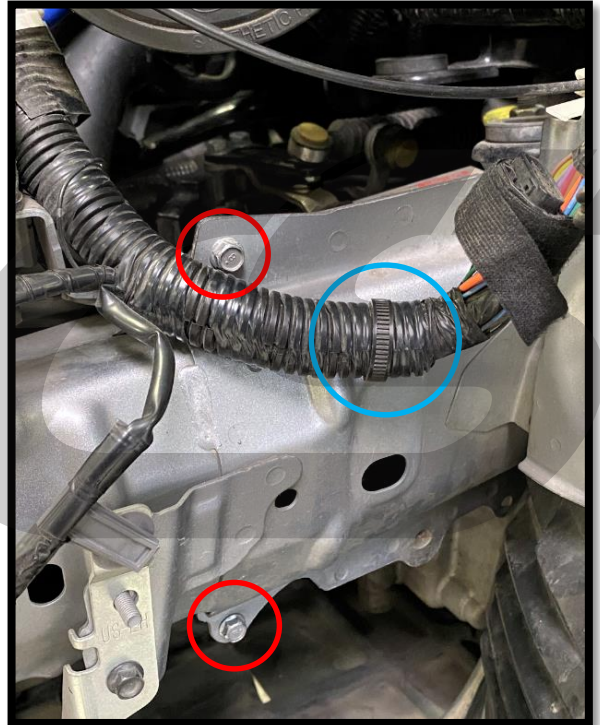

Figure 4a

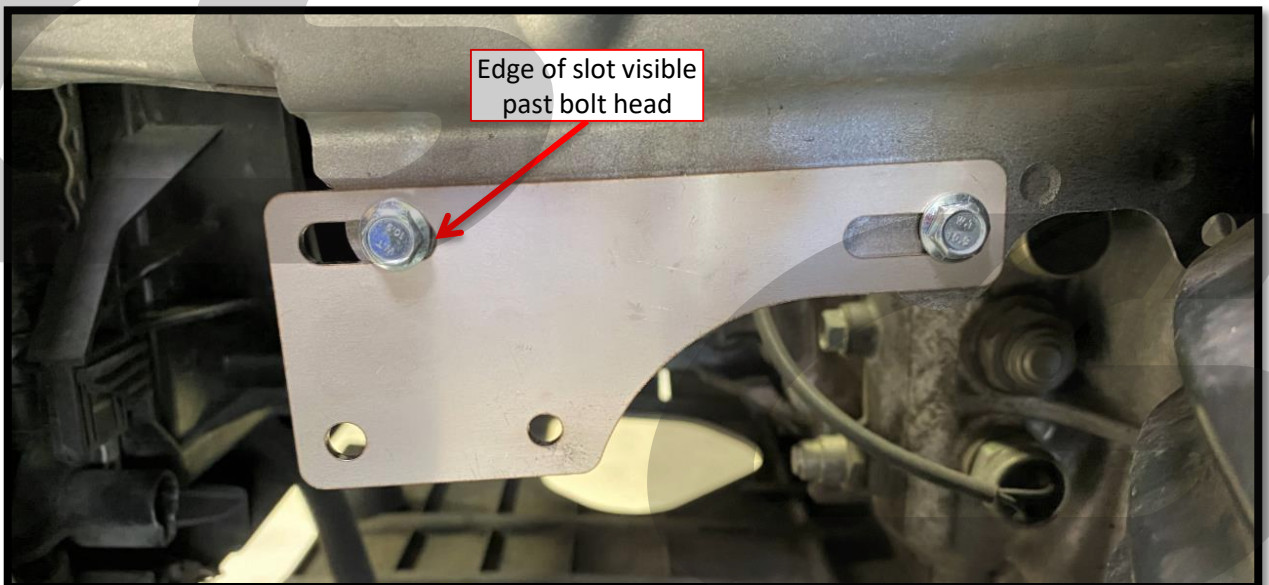

Figure 4b

DETAILED INSTRUCTIONS:

5. CorkSport Auxiliary Fuel Tank Installation

- a) Install the upper side mounting bracket loosely to the CS aux fuel tank. Use two supplied M6x1.0x16mm bolts threaded in hand tight so the bracket still is free to move slightly. Shown in **Figure 5a**.

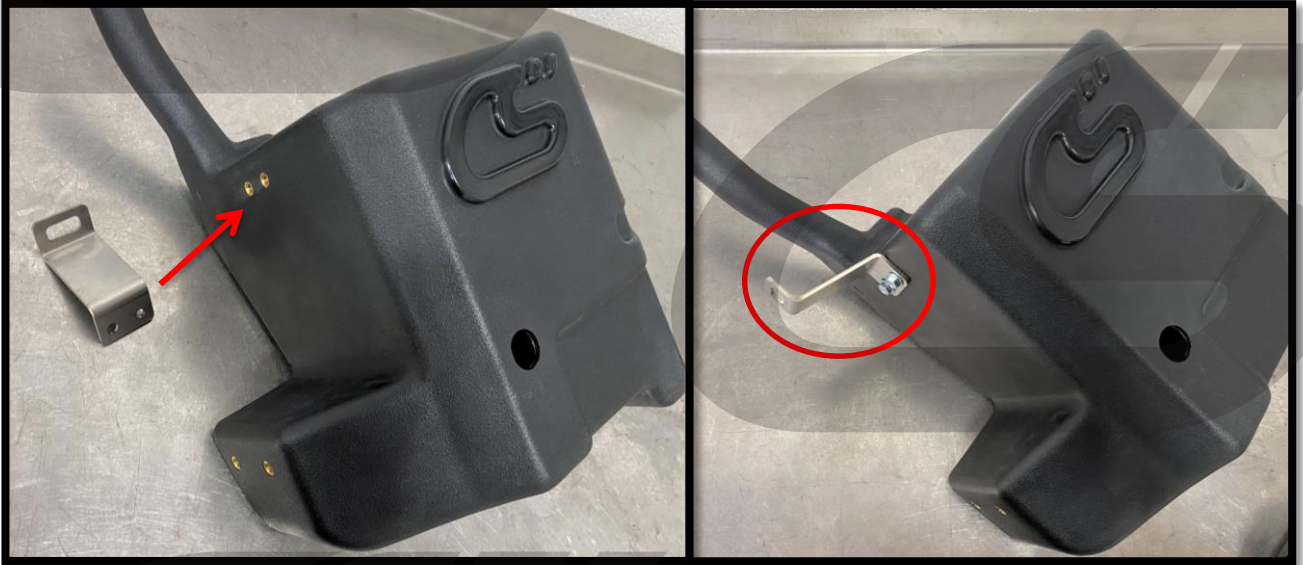

Figure 5a

- b) Install the top mounting bracket loosely to the CS aux fuel tank. Use two supplied M6x1.0x16mm bolts threaded in hand tight so the bracket still is free to move slightly. Shown in **Figure 5b**.



Figure 5b

DETAILED INSTRUCTIONS:

5. CorkSport Auxiliary Fuel Tank Installation (cont.)

- c) Lift the CorkSport Auxiliary Fuel Tank into position as shown in **Figure 5c**.

NOTE For 2010-2013 Mazdaspeed 3 owners, make sure the fill neck of the tank is behind the wiring harness as shown with **red arrow** in **Figure 5c**.

NOTE 2007-2009 owners, the wiring harness sits behind the fill neck, opposite of shown in **Figure 5c**.

- d) Begin securing the tank to the vehicle by loosely attaching the top bracket to the fender support. Use a supplied M6x1.0x16mm bolt and M6 nut threaded together hand tight so the bracket can still move around. The slotted hole to attach to is shown with **red arrow** in **Figure 5d**. This is shown completed in **Figure 5e** on the next page for reference.

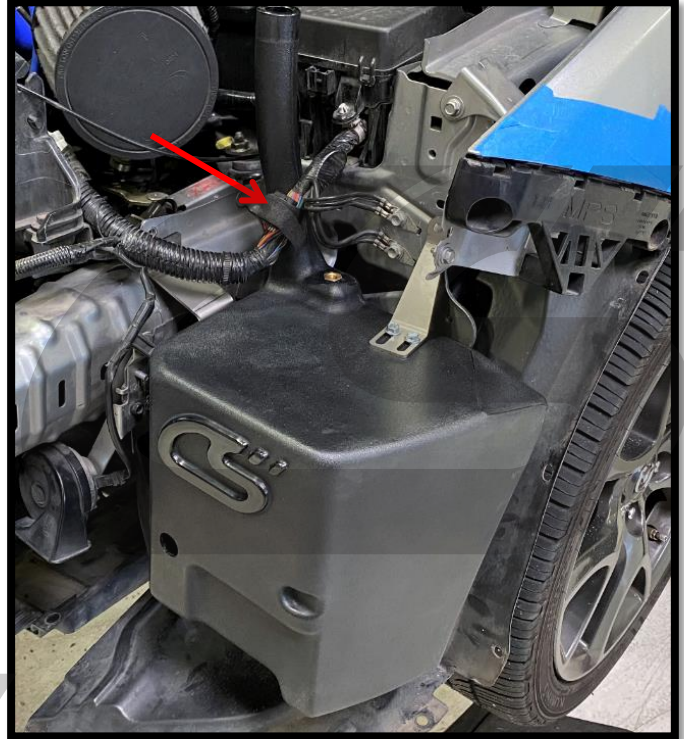

Figure 5c

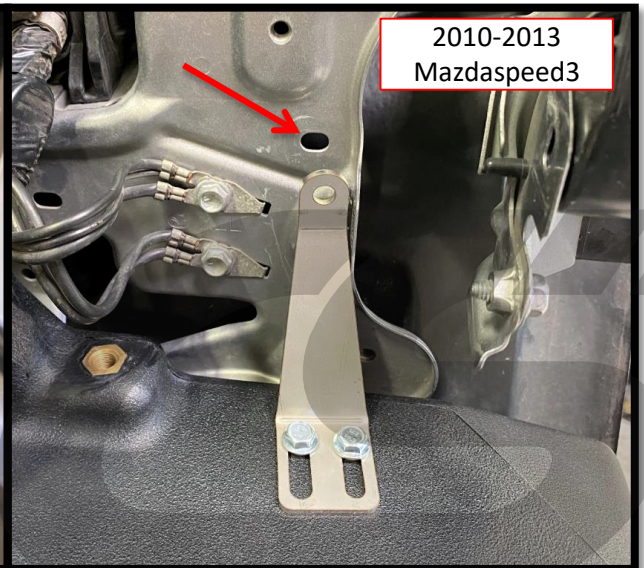
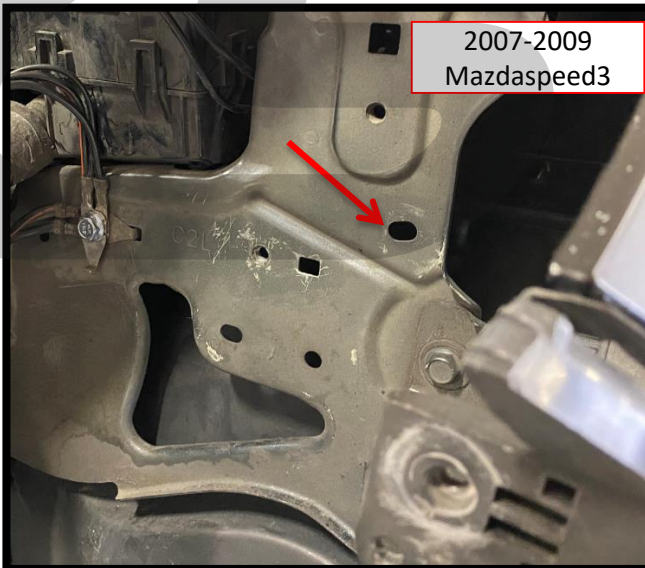

Figure 5d

DETAILED INSTRUCTIONS:

5. CorkSport Auxiliary Fuel Tank Installation (cont.)

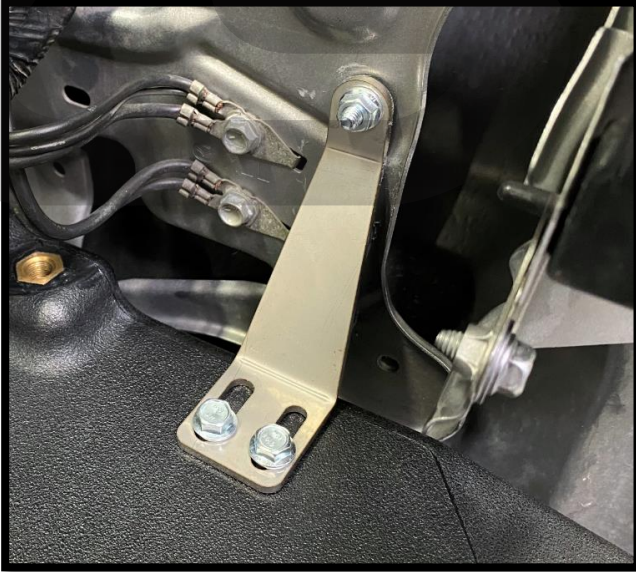

Figure 5e

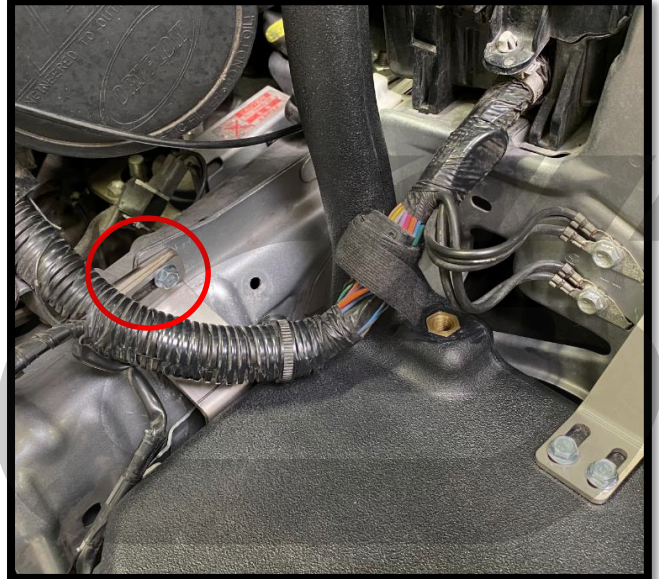

Figure 5f

- e) Secure the upper side bracket to the upper frame rail mounting location that was prepared earlier. Use the supplied slotted washer and an M6x1.0x16mm bolt (2007-2009 MS3 owners will also use an M6 nut). Hand tighten this location as shown in **Figure 5f**.



The slotted washer has different orientation depending on what generation of Mazdaspeed 3 you have. See **Figure 5g** below for proper slotted washer orientation. **Figure 5g** also shows approximate bolt location for best fitment.

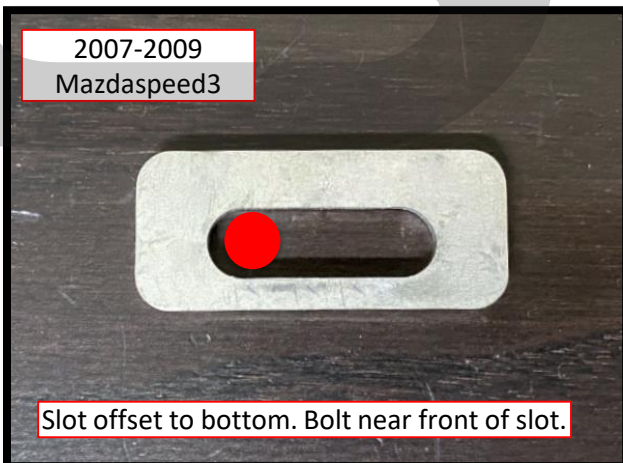

Figure 5g

DETAILED INSTRUCTIONS:

5. CorkSport Auxiliary Fuel Tank Installation (cont.)

- f) **Secure the lower side bracket to tank using two M6x1.0x16mm bolts.** These are easiest to see when viewed from under the car. Hand tighten the nuts in this location. Shown in **Figure 5h**.

- g) **Shift the tank around as needed to give best fitment for your car.** Double check fitment with headlight and double check fitment to front bumper (with headlight removed). The positions we found to fit best are shown below in **Figure 5i** and **Figure 5j** on the following page. All vehicles are slightly different, your "sweet spot" may vary.

- h) **Once happy with fitment, tighten all bolts/nuts until snug (5-8ft-lbs).**

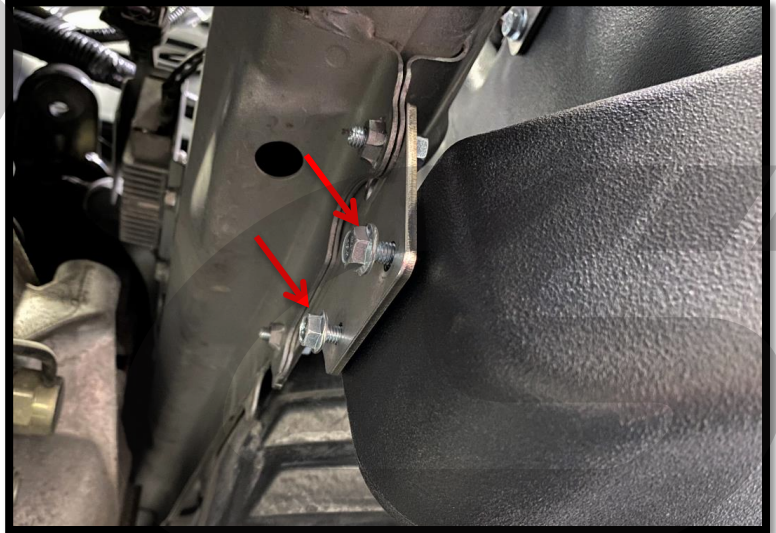
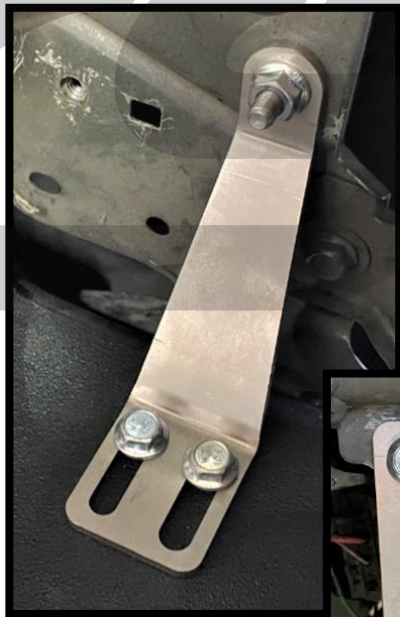

Figure 5h



Overtightening bolts that mount to the tank can result in damage to the tank.



2007-2009
Mazdaspeed3



Figure 5i



DETAILED INSTRUCTIONS:

5. CorkSport Auxiliary Fuel Tank Installation (cont.)



2010-2013
Mazdaspeed3

Figure 5j

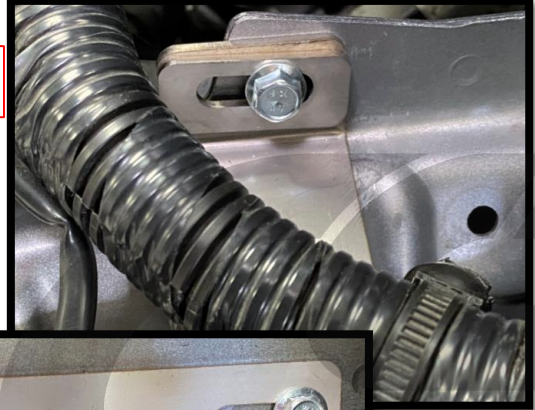

6. CorkSport Auxiliary Fuel Tank Setup

- a) Place the fill cap over the end of the fill neck. Push firmly and it will slide into place as shown in **Figure 6a**. A snug fit is normal in order to ensure a good seal. NOTE: your fill cap will be black, the silver cap shown was an early prototype.



Fill cap o-rings will be pre-lubed when shipped to you. We include some o-ring lube (shown below) that can be used on the o-rings if your cap becomes difficult to remove/install down the road.

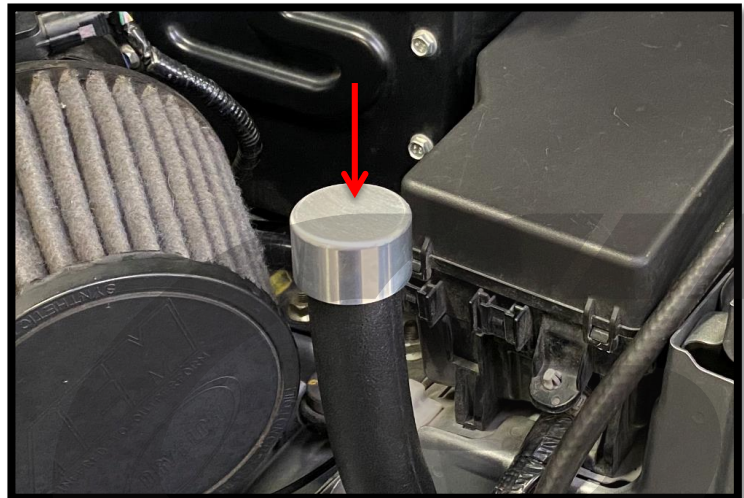

Figure 6a

DETAILED INSTRUCTIONS:

6. CorkSport Auxiliary Fuel Tank Setup (cont.)

- b) Install your aux fuel tank vent hose assembly into the bung near the fill neck. Hand tighten into the tank, then tighten fully (about 1.5 turns extra) using a 1/2" or 13mm wrench. Shown in **Figure 6b**.

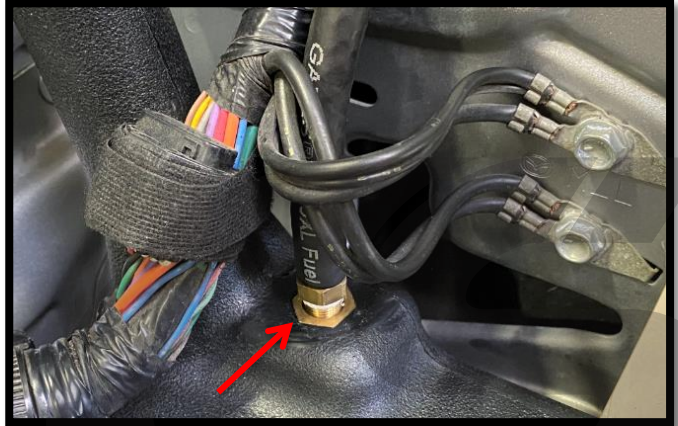

Figure 6b

- c) Run the vent hose along the top of the fender up to a place where it will be secure and free from any hot engine parts, moisture, or debris. Shown in **Figure 6c**.



You do not need to follow this exact path for your vent hose, just keep it away from heat, debris, and moisture.



Figure 6c

- d) Install the supplied low level sensor into the hole in the front of the tank. Insert it through the hole in the orientation shown in **Figure 6d**. The arrow on the side of the sensor should point down.
- e) Hand tighten the nut on the low level sensor then tighten 1/4" turn past hand tight to ensure a good seal. Do not overtight as it can cause damage to the threads of the sensor.

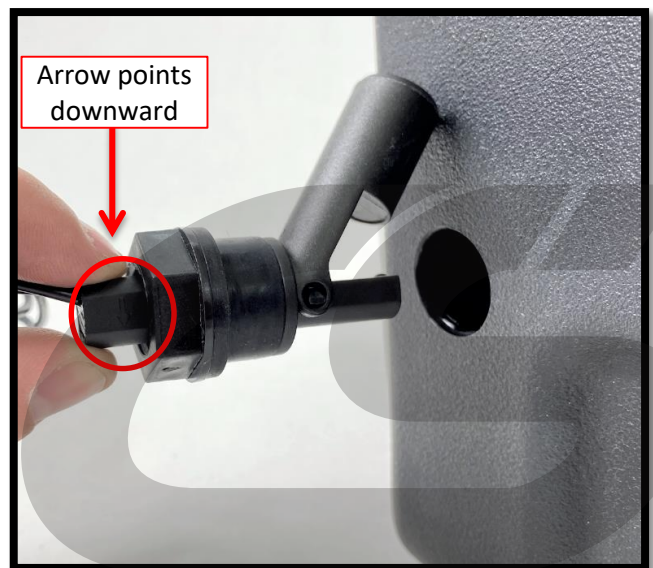
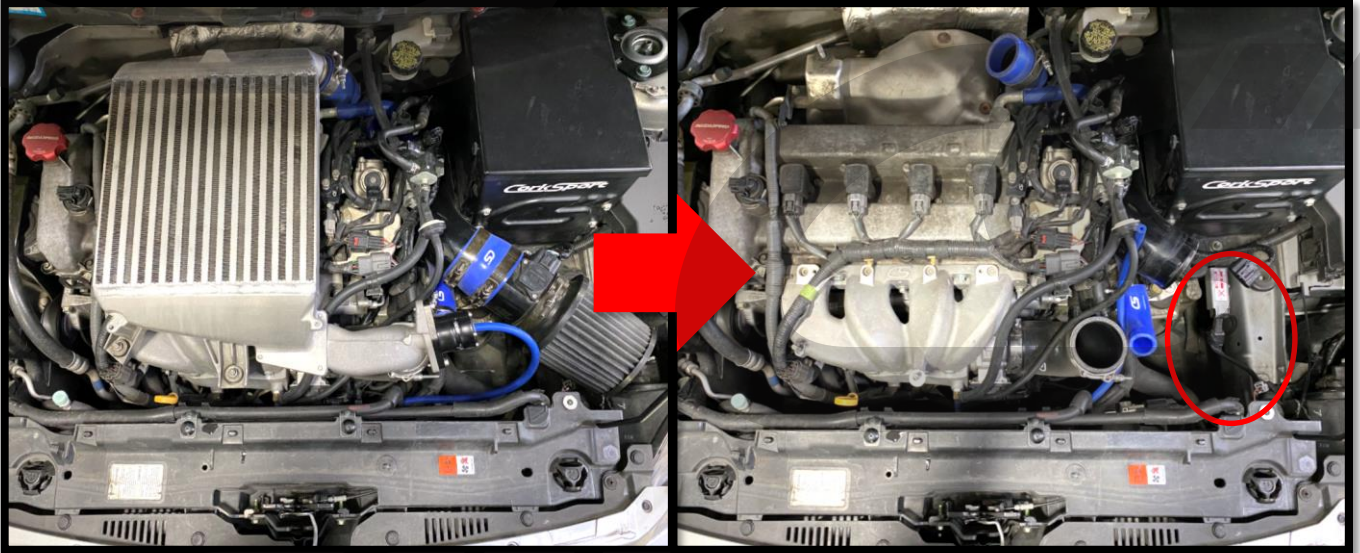

Figure 6d

DETAILED INSTRUCTIONS:

7. Preparing for Port Injection Installation

- a) Remove all components as needed until you have easy access to the top of your intake manifold and the driver's side frame rail (circled in red in Figure 7a).



For the car used in the images, Step 7a meant removing the TMIC and the MAF housing/filter. Depending on your setup, you may need to remove intercooler piping as well. As everyone's setup is different, Step 7a varies from car to car.

- b) If you have not installed your port injection ready intake manifold, do so at this time. Check out the CS intake manifold instructions for guidance at this link: <https://corksport.com/support/instructions/AXL-6-441-WEB.pdf>

- c) The OEM engine lifting point needs to be removed for fuel line clearance. Gain access by removing the two upper bolts on the power steering pump (GEN1) or idler pulley (GEN2) with a 12mm socket and ratchet. Circled in red in Figure 7b.

- d) Then, loosen the lower mounting point of the power steering pump/idler pulley. Location marked in blue in Figure 7b. The bracket will rotate over as shown in Figure 7c on the next page.

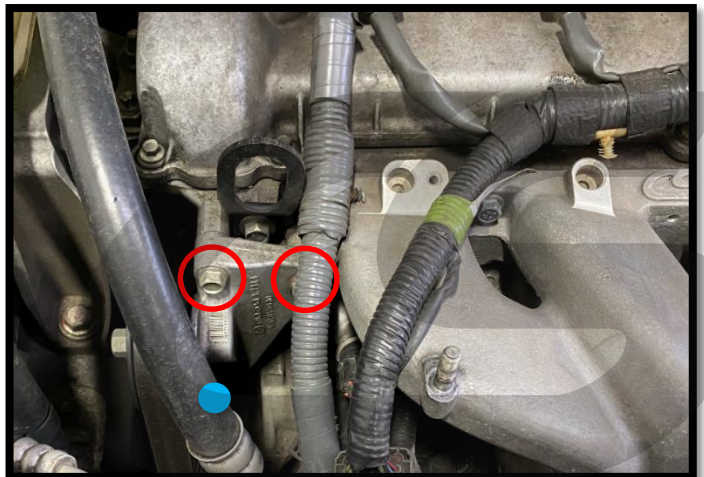

Figure 7b

DETAILED INSTRUCTIONS:**7. Preparing for Port Injection Installation (continued)**

e) The lifting point can then be removed using a 13mm socket and ratchet. Shown **circled in red** in **Figure 7c**.

f) Reattach the power steering pump (GEN1) or idler pulley (GEN2). Tighten the three 12mm bolts to 15-18ft-lbs. You may need to loosen tension on the belt to do so.



If you have a "wire tucked" wiring harness, you can skip steps 7g-7l as you already have the clearance gained in step 7g-7l.

g) The wiring bracket on the right side of the engine must be removed for clearance to the fuel rail. Start by unplugging the large gray plug and black plug. You must pull the red locking tab outward on the black plug before it can be released. Both plugs shown with **red arrows** in **Figure 7d**.

h) Remove the two bolts from the bracket near these two plugs using an 8mm socket and ratchet. **Circled in blue** in **Figure 7d**.

i) Unclip the black hose **circled in green** in **Figure 7d**.

j) Remove the final bolt holding the bracket to the engine using an 8mm socket and ratchet. Shown **circled in red** in **Figure 7e**.

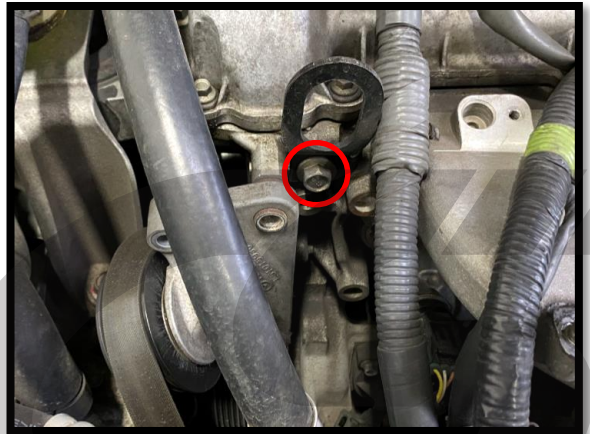
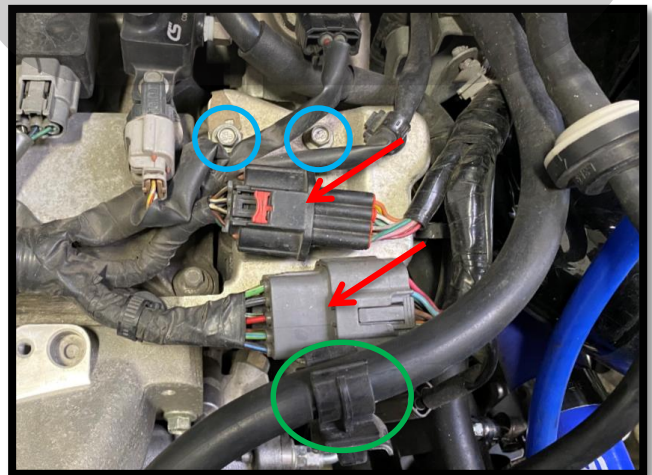
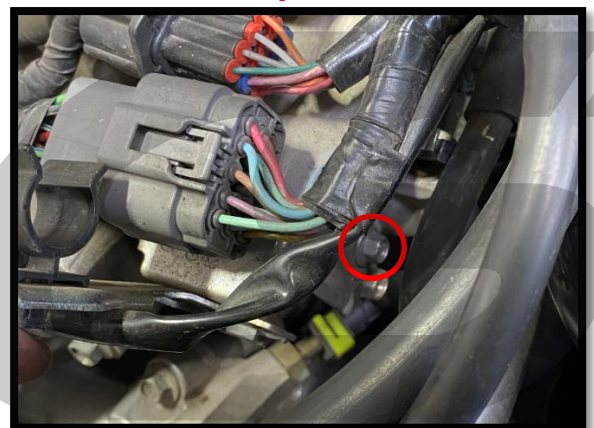
**Figure 7c****Figure 7d****Figure 7e**

DETAILED INSTRUCTIONS:

7. Preparing for Port Injection Installation (continued)

k) Rotate the mounting bracket so you can see the underside as shown in **Figure 7f**. Unclip the wiring plugs from the bracket and remove this bracket from the vehicle.

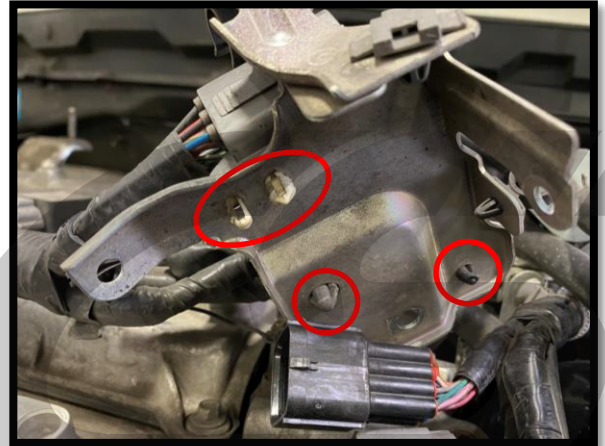

Figure 7f

l) Plug in the gray and black plugs unplugged in Step 7g.

m) Install your supplied Injectors and -6AN fuel rail at this time. Check out the CS intake manifold fuel rail instructions for guidance at this link:
<https://corksport.com/support/instructions/AXL-6-441-WEB.pdf>



If you have a "wire tucked" wiring harness, you can skip Step 7n.



The vehicle used for installation instructions was being used for mockup and did not have PI injectors installed at the time of capturing installation images.

n) Install the grounding wire that was disconnected in Step 7h onto one of your fuel rail mounting points. You will need to feed it underneath the coil pack harness as shown **in red** in **Figure 7g**.



Figure 7g



Failure to ground the wire shown in Figure 7g will cause issues with your car starting and running correctly.

DETAILED INSTRUCTIONS:

7. Preparing for Port Injection Installation (continued)

NOTE If you have a 2007-2009 (GEN1) Mazdaspeed 3, skip steps 7o- 7p. Continue your install on the next page.

- o) Remove the OEM fresh air duct from underneath the radiator cowl/core support. Begin by pulling the two hoses away from the core support. Shown with **red arrows** in **Figure 7h**. Leave the hoses out of the way until a later step.
- p) Remove the two screw style push clips using a Phillips screwdriver (**circled in blue** in **Figure 7h**). Then remove the OEM fresh air duct. Shown removed in **Figure 7i**.

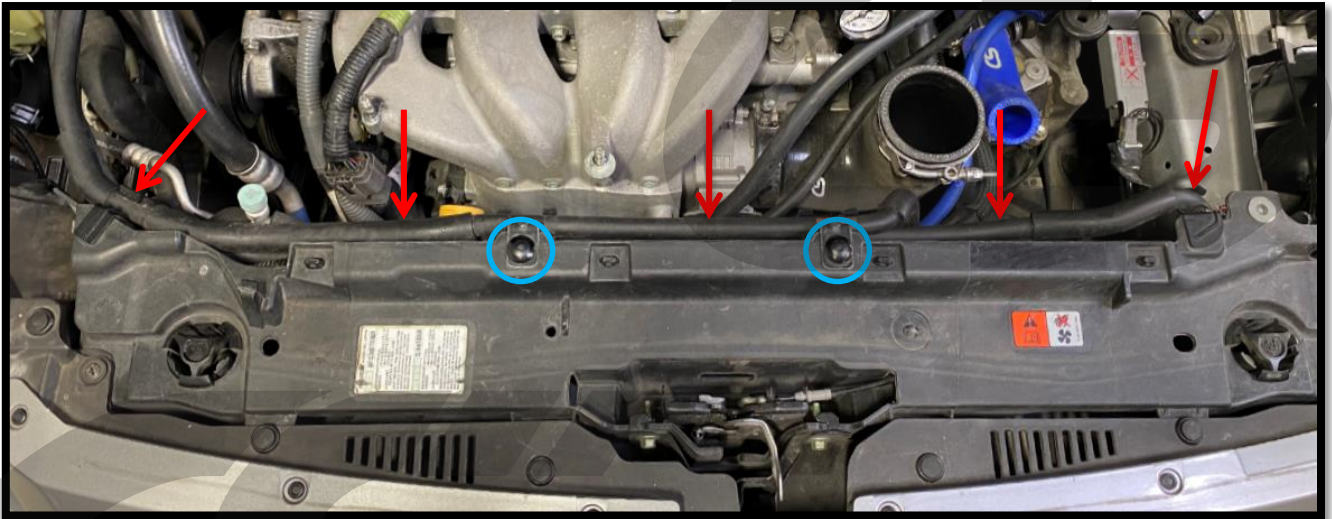

Figure 7h



Figure 7i

DETAILED INSTRUCTIONS:**8. Fuel Rail Setup****NOTE**

All AN fittings that come with an O-ring in the package will need the O-ring installed as shown in **Figure 8a**. Failure to install the O-ring WILL result in fuel leaks. The O-ring installs on the side without the "flare" as shown.

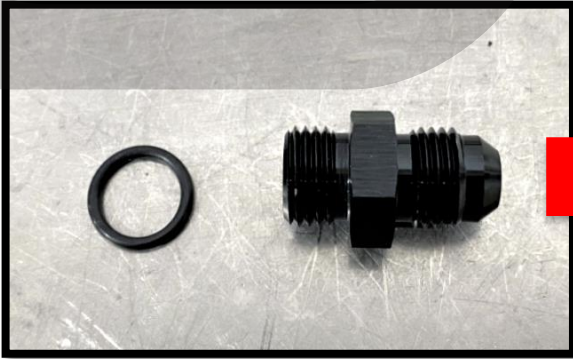
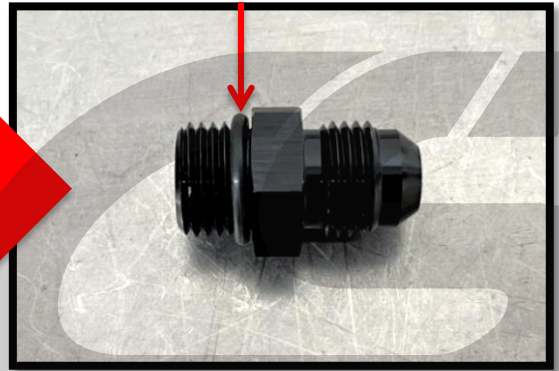
**Figure 8a**

- Assemble two supplied 16826 fittings with their supplied O-rings like shown in **Figure 8a**.
- Install one fitting into each end of the fuel rail as shown in **Figure 8b**. Tighten each fitting until snug using an 11/16" or adjustable wrench.

**Figure 8b**

- Locate the supplied Fuelab fuel pressure gauge. Apply fuel/oil safe PTFE thread tape or sealant to the threads as shown in **Figure 8c**.

**Figure 8c**

DETAILED INSTRUCTIONS:

8. Fuel Rail Setup (continued)

- d) Assemble one supplied 16826 fitting, one 16860 fitting, and one 10992 fitting with their supplied O-rings.
- e) Locate the AEM Fuel Pressure Regulator and install the supplied fittings and gauge as shown in **Figure 8c**.
- Tighten 16826 and 16860 fittings until snug using a 11/16" or adjustable wrench.
 - Tighten the 10992 fitting until snug with a 6mm Allen wrench/socket.
 - Tighten the gauge hand tight, plus 0.5-1.5 turns with an 11mm wrench until it lines up as shown.

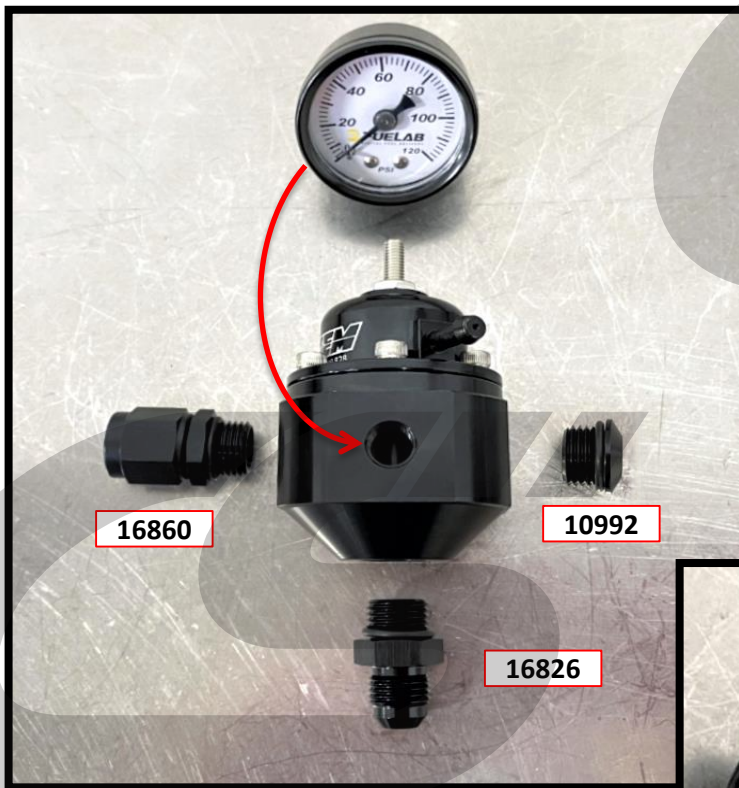

Figure 8c



DETAILED INSTRUCTIONS:

8. Fuel Rail Setup (continued)

- f) Install the regulator assembly onto the right side of the fuel rail as shown in **Figure 8d**. The regulator will touch the wiring plugs in this area if you do not have a wire tuck. Angle it so the gauge faces slightly upward for best clearance for the outlet (bottom) fitting, and tighten the regulator assembly to the fuel rail with an 11/16" or adjustable wrench until snug.
- g) Connect a vacuum/boost pressure line from the intake manifold to the port near the top of the fuel pressure regulator, **circled in blue in Figure 8d**. The top of the regulator can be removed and rotated as needed to allow for best clearance for this vacuum/boost line. Use one of the supplied tee fittings and the supplied vacuum hose to complete this connection.

NOTE

The BPV boost/vacuum reference is a great option to tee into for the fuel pressure regulator boost/vacuum reference.

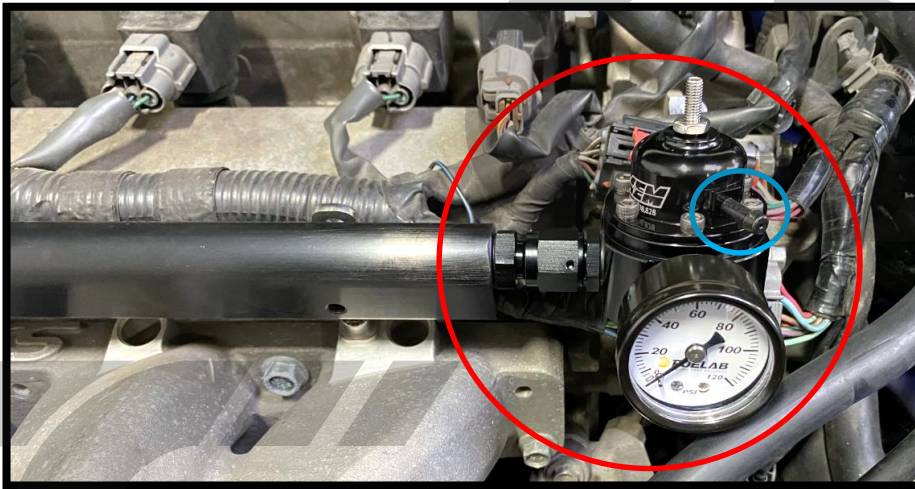

Figure 8d

9. Fuel Filter Setup

NOTE

Your fuel filters come with assembly instructions in the package but we include the information in this section to ensure correct filter assembly & operation.

- a) Open the package and remove the end caps of the filter marked "DWFF70". The end caps can be removed with a 34mm or adjustable wrench. All components in the box are shown in **Figure 9a**.



Figure 9a

DETAILED INSTRUCTIONS:

9. Fuel Filter Setup (continued)

- b) Apply the supplied grease to the supplied O-ring and additional grease to the O-ring groove in one of the caps. Position the O-ring in this groove and ensure it is sitting flat and level. The grease lubricates the O-ring and keeps it in position through the remaining assembly steps. **Figure 9b** shows a correctly positioned O-ring and an incorrectly positioned O-ring.



Figure 9b

- c) Insert the filter element onto the O-ring. Ensure the "open" end of the filter with the micron size label sits against the O-ring. This is shown in **Figure 9c**. The closed end of the filter with the magnet will face upwards.



Figure 9c

DETAILED INSTRUCTIONS:**9. Fuel Filter Setup (continued)**

d) Before continuing with assembly, note the orientation of the brackets shown in **Figure 9d**. The end with the O-ring and filter is the **OUTLET** of the filter and is labeled below.

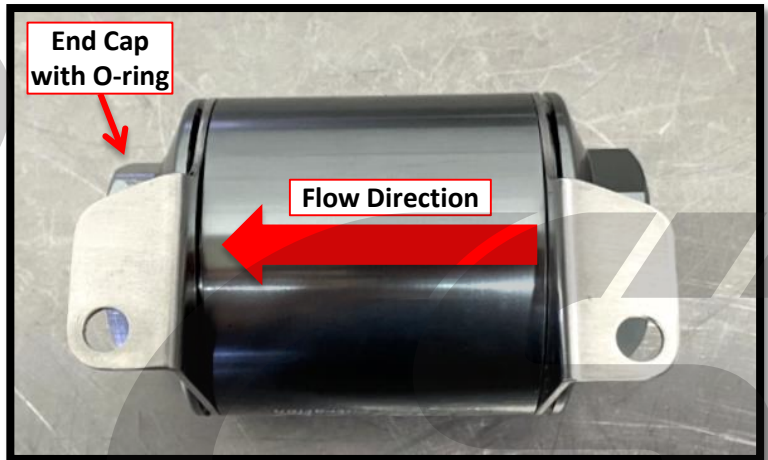
**Figure 9d**

e) Once your bracket orientations match **Figure 9d**, the end cap with the O-ring and filter can be installed into the body of the filter on the side shown. Tighten the end cap to 15-20ft-lbs with a 34mm or adjustable wrench.

f) Place the large end of the spring into the other end cap as shown in **Figure 9e**.

**Figure 9e**

g) Then install the endcap onto the main body of the filter. You will need to compress the spring to begin threading the end cap. Tighten the end cap to 15-20ft-lbs with a 34mm or adjustable wrench.

h) Assemble two supplied 16828 fittings with their supplied O-rings.

i) Install one fitting into each end of the "DWFF70" fuel filter as shown in **Figure 9f**. Tighten each fitting until snug using an 1" or adjustable wrench.

**Figure 9f**

DETAILED INSTRUCTIONS:

9. Fuel Filter Setup (continued)

- j) Repeat Steps 9a-9g for the "DWFF110" Filter with one exception: **remove the mounting brackets from the filter before tightening the end caps.** The mounting brackets are not used with this filter. Shown completed in **Figure 9g**.
- k) Assemble two supplied 16836 fittings with their supplied O-rings.
- l) Install one fitting into each end of the "DWFF110" fuel filter as shown in **Figure 9g**. Tighten each fitting until snug using an 1" or adjustable wrench.

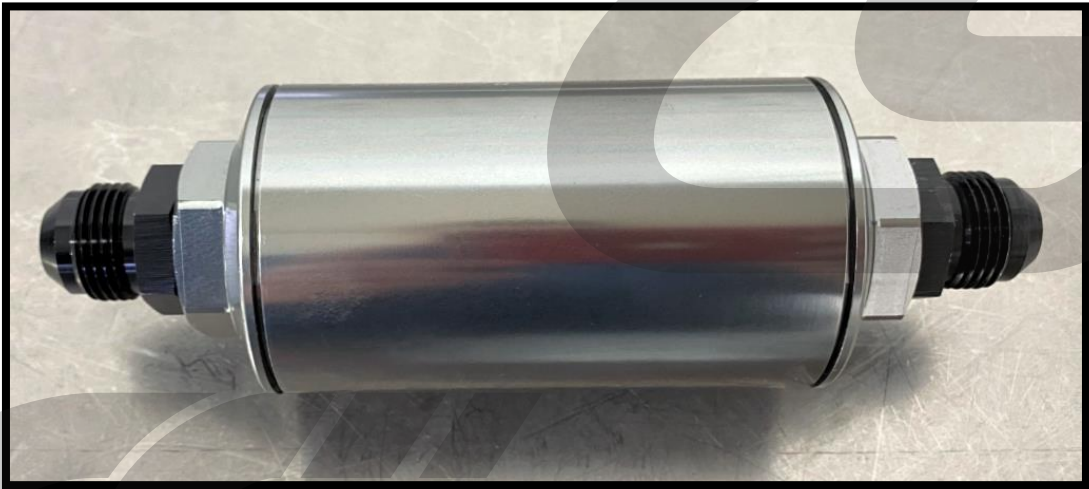

Figure 9g

10. Fuel Pump Setup & Installation

- a) Install the two supplied blue fittings onto either end of the Quantum Fuel Pump. They only install in one location and in one orientation. Make sure you use the supplied crush washers to prevent fuel leaks. Tighten until snug using a 5/8" (small fitting) and 15/16" (large fitting) or adjustable wrench. Shown completed in **Figure 10a**, crush washers shown with **red arrows**.



Figure 10a

DETAILED INSTRUCTIONS:

10. Fuel Pump Setup & Installation (continued)

- b) Locate the supplied 11389 fitting. Apply fuel/oil safe PTFE thread tape or sealant to the threads as shown in **Figure 10b**.
- c) Install this fitting into the feed port of the CorkSport Aux Fuel Tank. Tighten it hand tight, plus 1-1.5 turns with a 1 1/16" or adjustable wrench. Shown completed with **red circle** in **Figure 10c**.

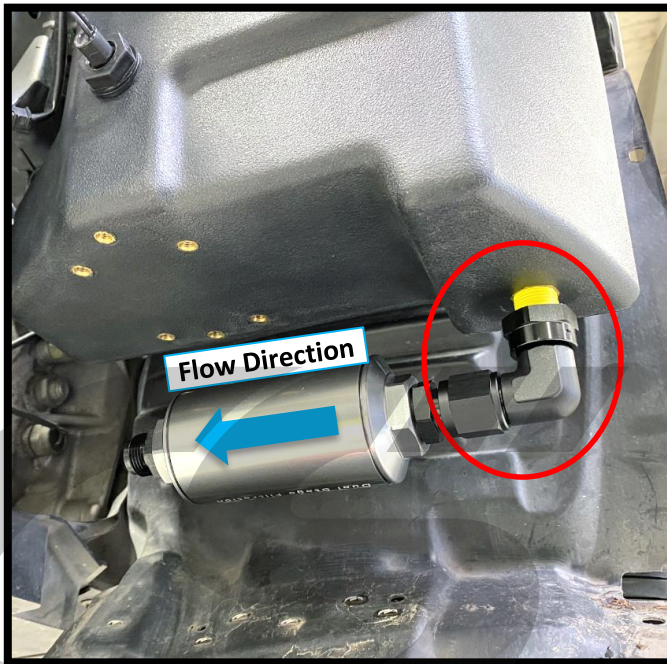

Figure 10c

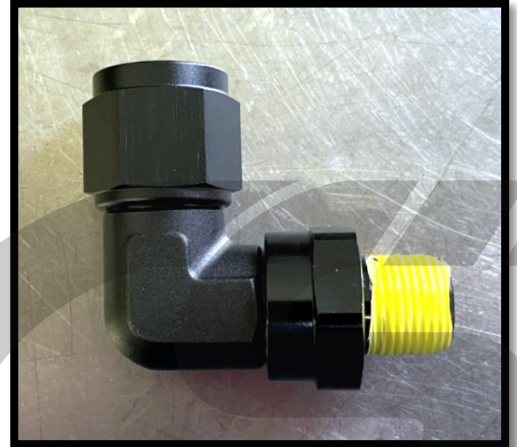

Figure 10b

- d) Install the "DWFF110" filter onto the 11389 fitting as shown in **Figure 10c**. Ensure the flow direction of the filter matches what is shown in **Figure 10c**. Tighten the filter to the 11389 fitting until snug using a 1" or adjustable wrench.

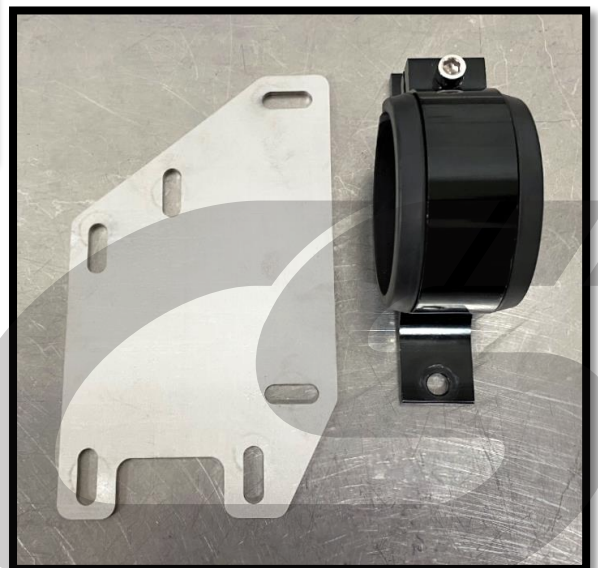

Figure 10d

- e) Locate the pump mounting bracket and pump mounting plate. Orient them as shown in **Figure 10d**.

DETAILED INSTRUCTIONS:

10. Fuel Pump Setup & Installation (continued)

- f) Loosely attach the pump mounting bracket to the pump mounting plate. Use supplied M6x1.0x16mm bolts and M6 flange nuts. Match hardware orientation shown in **Figure 10e**. Do not tighten as you need the adjustability for later steps.
- g) Line up the pump mounting bracket & plate assembly onto the bottom of the tank. Hole locations shown with **red circles** in **Figure 10f**.
- h) Attach the pump bracket and plate assembly to the bottom of the CS aux fuel tank. Use the supplied 1/4" tall spacers between the plate and the tank. Secure using supplied M6x1.0x20mm bolts. Leave the bolts loose for now. Shown complete in **Figure 10g**.



Figure 10e

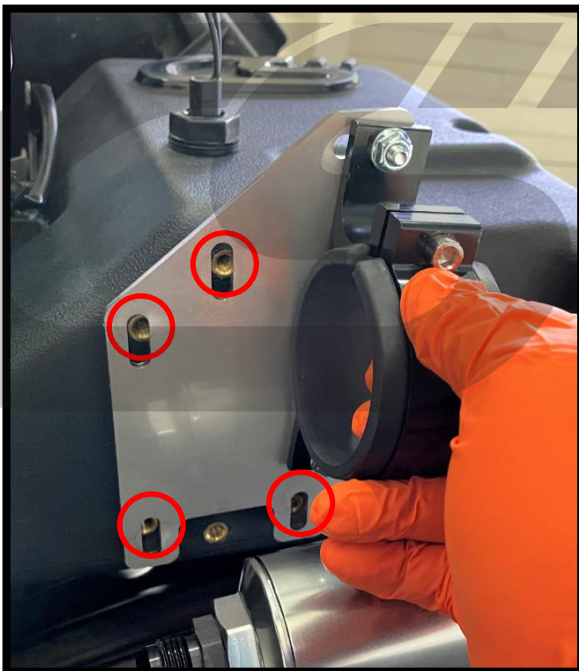

Figure 10f

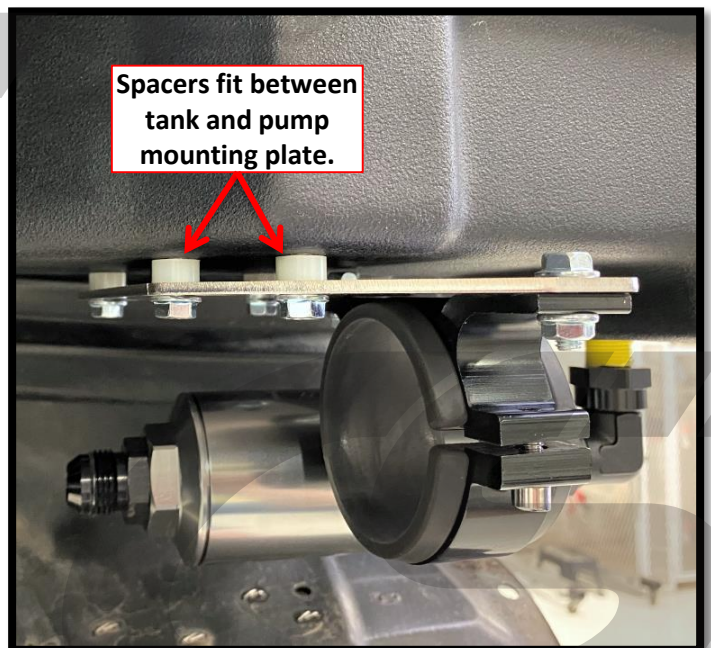

Figure 10g

DETAILED INSTRUCTIONS:

10. Fuel Pump Setup & Installation (continued)

- i) Insert the fuel pump into the fuel pump mounting bracket, with the large blue fitting facing towards the engine. Remove the screw in the fuel pump bracket so the bracket is flexible enough to insert the pump. Shown inserted in **Figure 10h**.
- j) Attach the supplied 10734 fitting onto the end of the filter as shown with **red arrow** in **Figure 10h**. Only hand tighten for now.
- k) Attach the supplied 10784 fitting onto the end the previous fitting as shown with **blue arrow** in **Figure 10h**. Only hand tighten for now.



On our shop cars, this fitting arrangement gave the best clearance to all components. If struggling with clearance to your FMIC piping, the 10734 and 10784 fittings can be switched for some extra room. Ensure the fuel pump does not contact the sumped portion of the tank if this switch is performed.



Figure 10h

DETAILED INSTRUCTIONS:**10. Fuel Pump Setup & Installation (continued)**

- l) Connect the large blue fitting on the fuel pump to the 10784 fitting. You will need to move the fuel pump around in the mount as you thread the components together. Only hand tighten for now.
- m) Rotate the fuel pump until the electrical connectors are oriented similar to **Figure 10i**. This orientation gives the best clearance for fuel lines and wiring.
- n) Shift all components around until everything is sitting parallel and there is no binding in any of the fittings. Once happy with fitment, tighten the three AN connections until snug using a 1" or adjustable wrench. **Figure 10j** shows the AN connections with **red arrows** and the approximate orientation for all components.
- o) Tighten the four pump mounting plate bolts and two pump mounting bracket bolts until snug using a 10mm socket or wrench. Bolts shown with **blue arrows** in **Figure 10j**. Note, two bolts are not visible.
- p) Finally, tighten the fuel pump mount clamping bolt until snug using a 3/16" Allen wrench/socket. Location shown **circled in green** in **Figure 10j**.

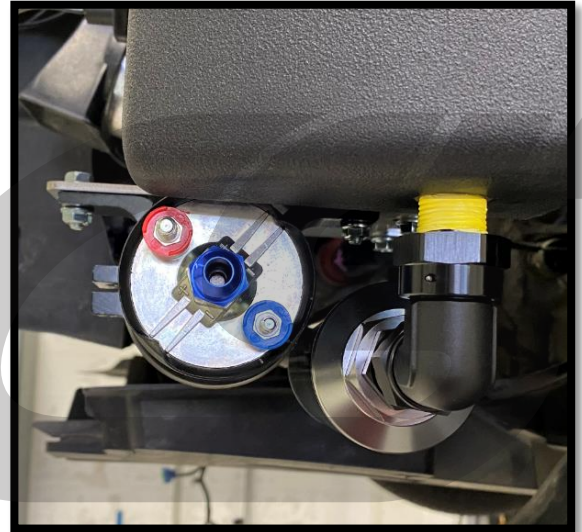
**Figure 10i**

Overtightening bolts that mount to the tank can result in damage to the tank.

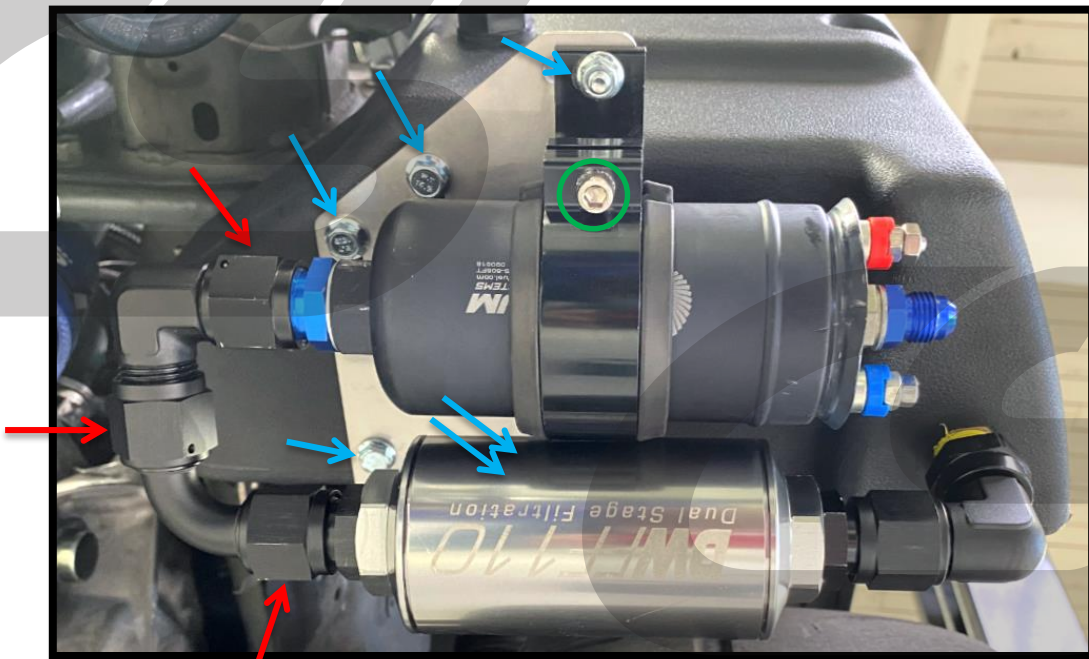
**Figure 10j**

DETAILED INSTRUCTIONS:

11. Post Pump Fuel Filter Installation

NOTE 2010-2013 Mazdaspeed 3 owners skip to Step 11g on the next page.

- The post-pump fuel filter will mount to the underside of the radiator cowl/core support.
- Cut out the hole drilling template shown in **Figure 11a**. This template aligns with the vertical support and vertical edge of the radiator core support as shown in **Figure 11b**. There is quite a lot of flexibility on GEN1 filter mounting, this is just our recommended location.
- Using the template as a guide, mark the two mounting locations as shown **circled in red in Figure 11b**.
- Double check the hole spacing using your assembled "DWFF70" filter as a guide.
- Once happy with spacing and alignment, drill the two mounting holes with a 1/4" drill bit.

! Be careful while drilling to prevent any damage to components near or underneath the drilling locations.

- Clean the holes to remove any burrs or sharp edges. Once complete, your holes should look like **Figure 11c**.

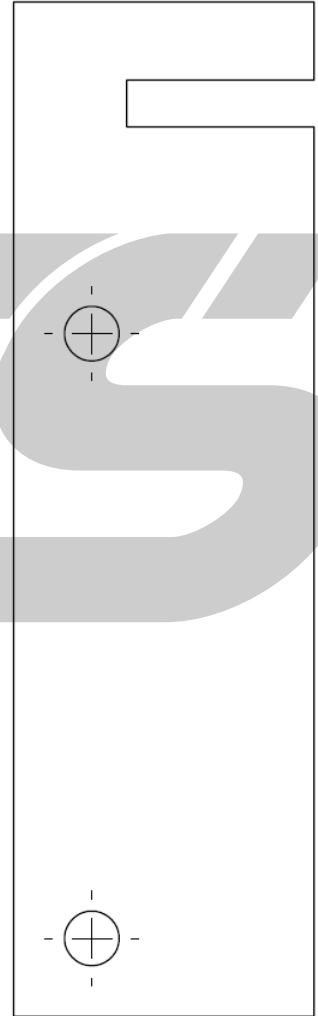

Figure 11a

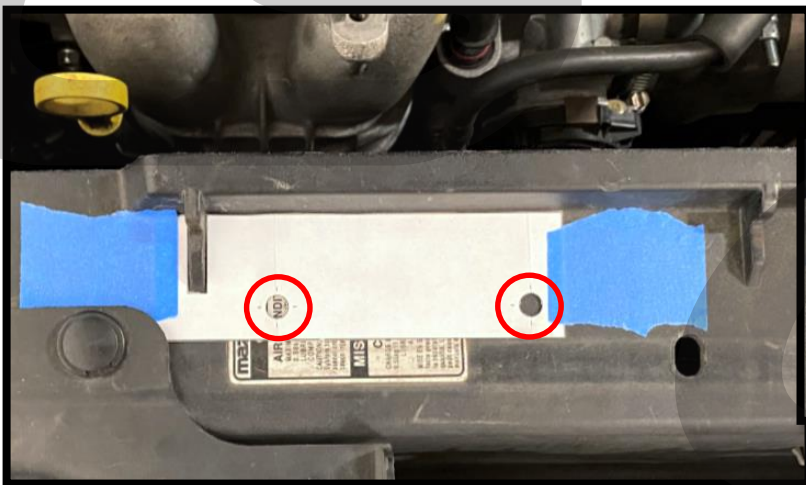

Figure 11b



Figure 11c

DETAILED INSTRUCTIONS:

11. Post Pump Fuel Filter Installation (continued)

NOTE

2007-2009 Mazdaspeed 3 owners skip to step 11m on the next page.

- g) The post-pump fuel filter will mount to the underside of the radiator cowl/core support. Locate the OEM hole to the left of the hood latch. This is one of the holes that will be used for mounting. Location circled in red in **Figure 11d**.

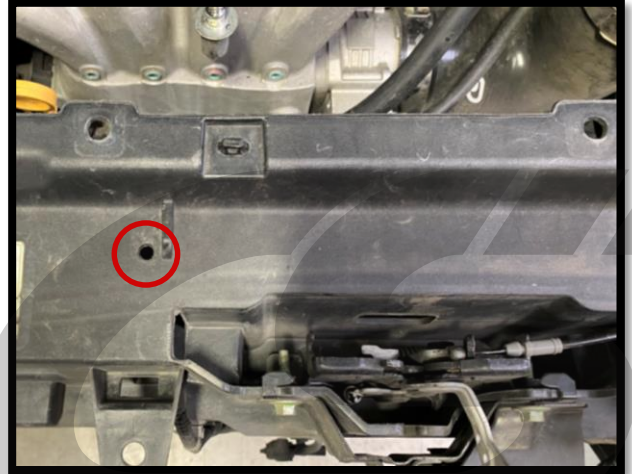

Figure 11d

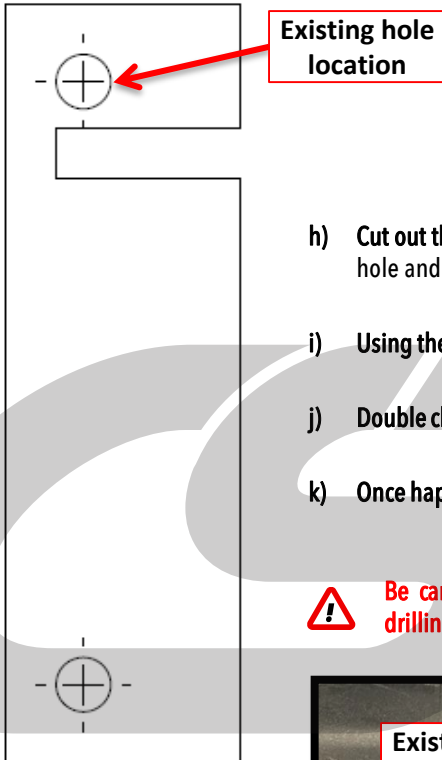

Figure 11e

- h) Cut out the hole drilling template shown in **Figure 11e**. This template aligns with the existing hole and radiator core support as shown in **Figure 11f**.
- i) Using the template as a guide, mark the second mounting location as shown in **Figure 11f**.
- j) Double check the hole spacing using your assembled "DWFF70" filter as a guide.
- k) Once happy with spacing and alignment, drill the second mounting hole with a 1/4" drill bit.



Be careful while drilling to prevent any damage to components near or underneath the drilling location.

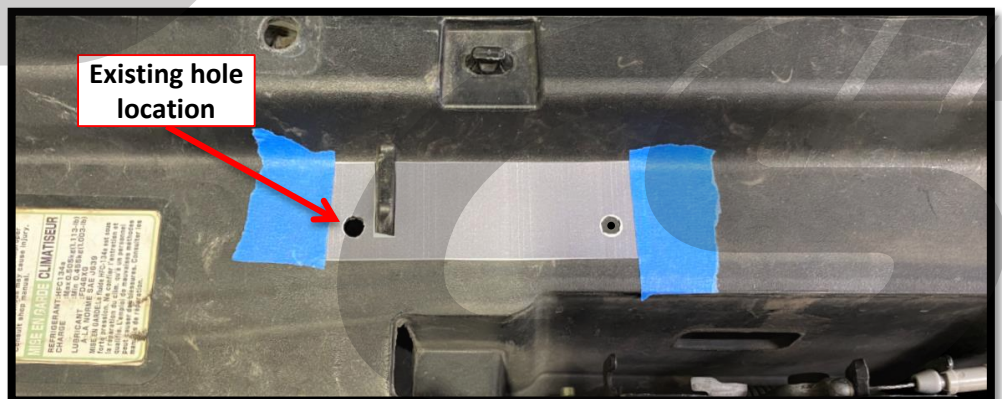

Figure 11f

DETAILED INSTRUCTIONS:

11. Post Pump Fuel Filter Installation (continued)

- l) Clean the holes to remove any burrs or sharp edges. Once complete, your holes should look like **Figure 11g**.

- m) Mount your assembled DWFF70 to the radiator core support using supplied M6x1.0x16mm bolts and M6 nuts. Ensure the flow direction of the filter matches what is shown in **Figure 11h**. Tighten until snug with a 10mm socket and wrench.

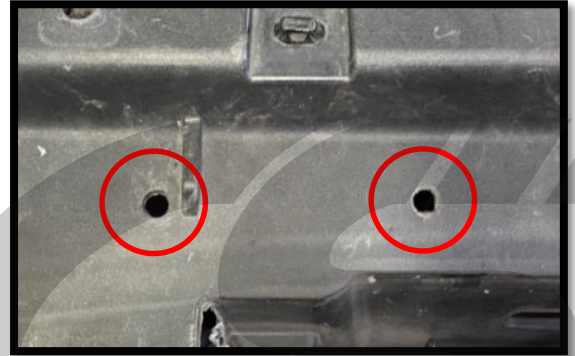

Figure 11g

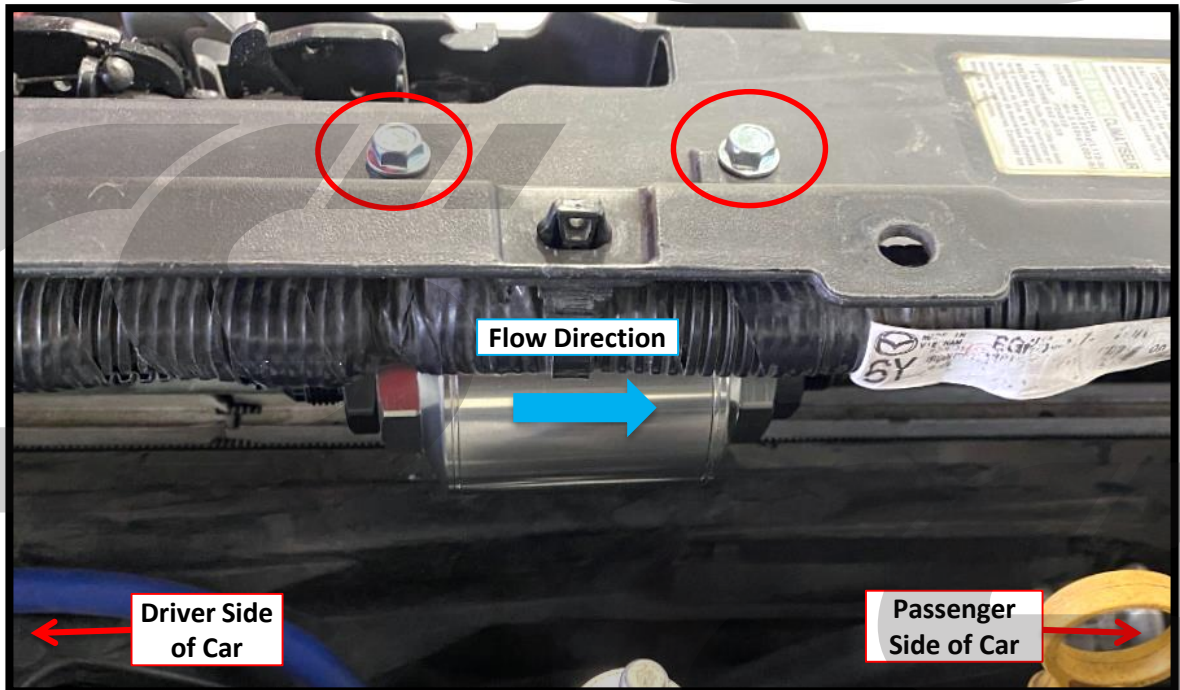

Figure 11h

DETAILED INSTRUCTIONS:

12. Fuel Line Installation

- a) Locate the longest fuel line in your kit. It also has a sharp bend on one end. Shown in **Figure 12a**.
- b) Insert the straight end of the fuel line up into the engine bay as shown in **Figure 12b**. Location is not important until a later step.

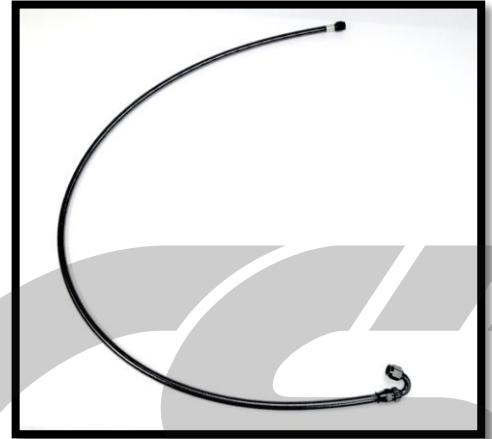

Figure 12a

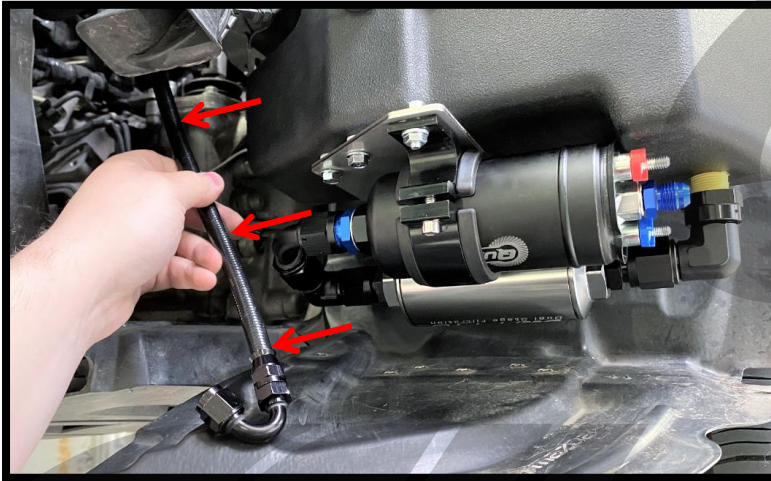

Figure 12b

- c) Route this fuel line over the top of the DWFF110 filter, and connect it to the pump outlet fitting as shown in **Figure 12c**. Do not tighten the fuel line yet.

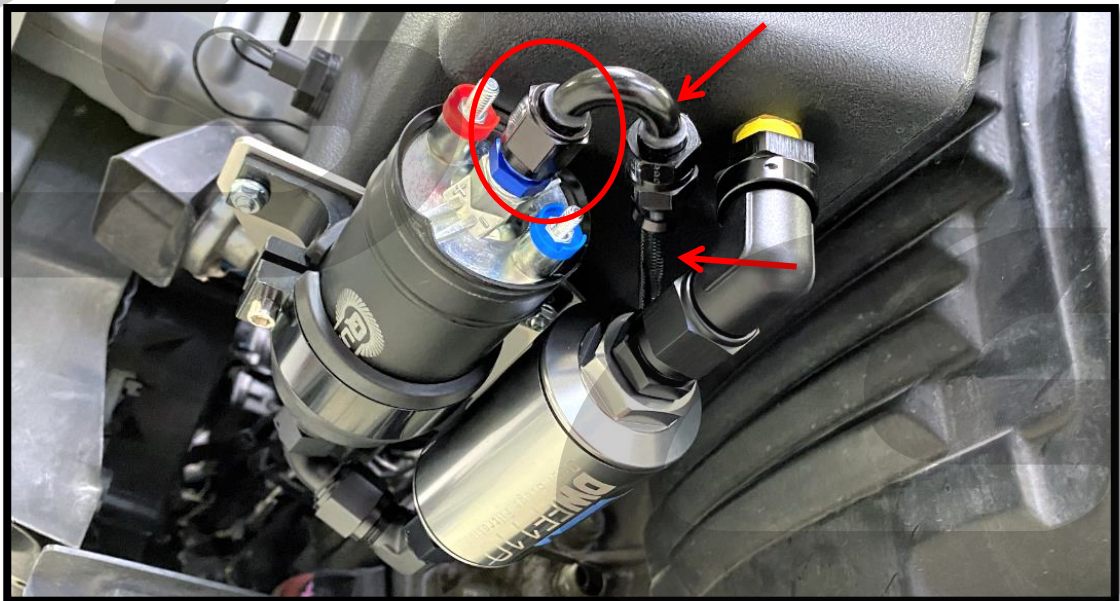
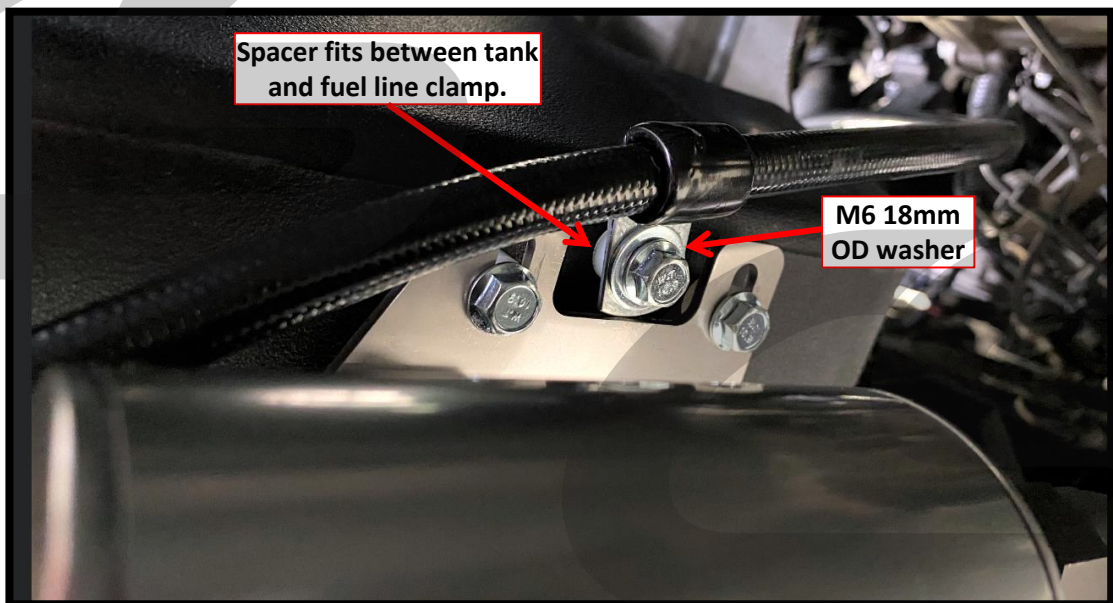

Figure 12c

DETAILED INSTRUCTIONS:**12. Fuel Line Installation (continued)**

- d) Attach one of the supplied fuel line clamps to the fuel line as shown in **circled in red** in **Figure 12d**.
- e) Secure the fuel line to the CS aux fuel tank in the **location shown**. Use the final 1/4" tall spacer between the clamp and the tank and secure it all with a supplied M6x1.0x20mm bolt. Use a supplied 18mm OD washer as shown. Shown complete in **Figure 12e**.
- f) Rotate the line as needed to ensure it does not contact the fuel filter, mounting bracket, or tank.
- g) Once satisfied with line fitment, tighten the 10mm bolt holding the line clamp until snug.
- h) Then, tighten the fuel line to the pump outlet until snug using an 11/16" or adjustable wrench.

**Figure 12d****Figure 12e**

DETAILED INSTRUCTIONS:**12. Fuel Line Installation (continued)**

- i) Route this fuel line up under the radiator cowl and connect it to the DWFF70 filter as shown circled in red in **Figure 12f**. Tighten until snug using an 11/16" or adjustable wrench.
- j) Locate the short fuel line in your kit. Shown in **Figure 12g**.
- k) Connect the straight end of the short fuel line to the outlet of the DWFF70 filter. Shown circled in red in **Figure 12h**.
- l) Connect the 90° end of the short fuel line to the passenger side of the fuel rail. Shown circled in blue in **Figure 12h**.
- m) Tighten both ends of the short fuel line until snug using an 11/16" or adjustable wrench. Fuel line routing shown with yellow lines in **Figure 12h** for reference.

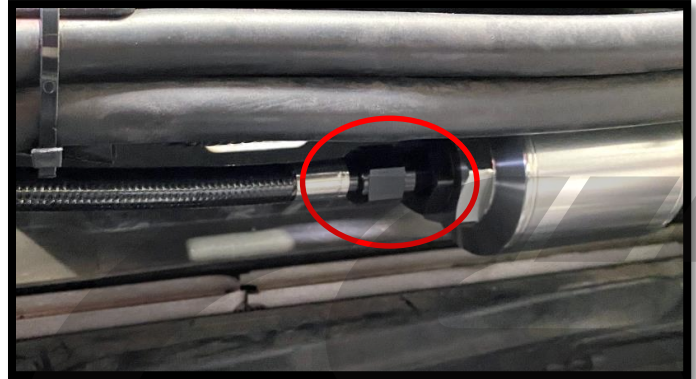
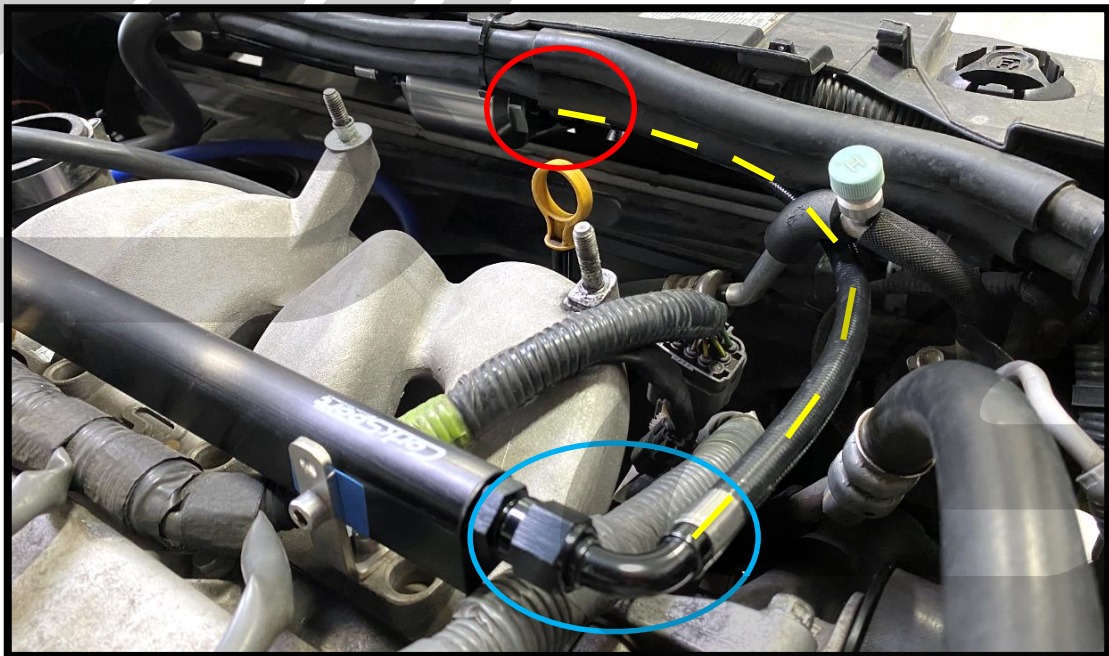
**Figure 12f****Figure 12g****Figure 12h**

DETAILED INSTRUCTIONS:

12. Fuel Line Installation (continued)

n) 2010-2013 Mazdaspeed3 Owners: We recommend you secure the coolant lines that were moved out of the way during Step7o at this time. Use a few zip ties and the existing holes in the radiator cowl as shown with **red arrows** in **Figure 12i**.

o) Locate the supplied 10258 fitting. Apply fuel/oil safe PTFE thread tape or sealant to the threads as shown in **Figure 12j**.

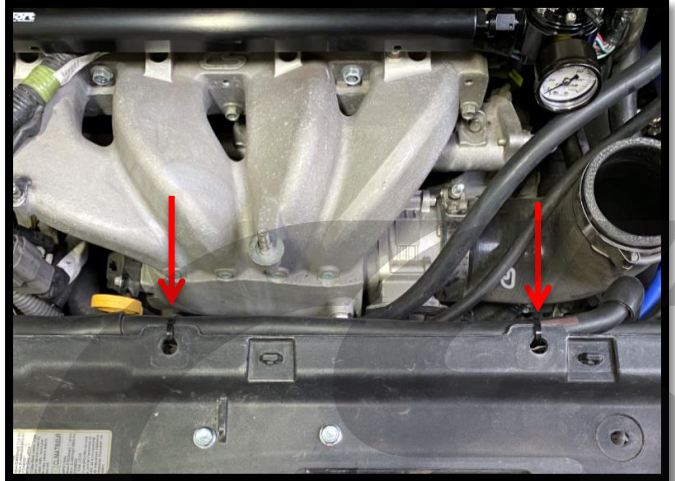

Figure 12i



Figure 12j



The fitting shown in these instructions is a swivel type fitting. The fitting in your kit will look slightly different, but functions the exact same.

p) Install this fitting into the return port of the CorkSport Aux Fuel Tank. Tighten it hand tight, plus 1-1.5 turns with a 3/4" or adjustable wrench. Ensure the end of the fitting points toward the engine/center of the vehicle and slightly downward. Shown completed with **red circle** in **Figure 12k**.

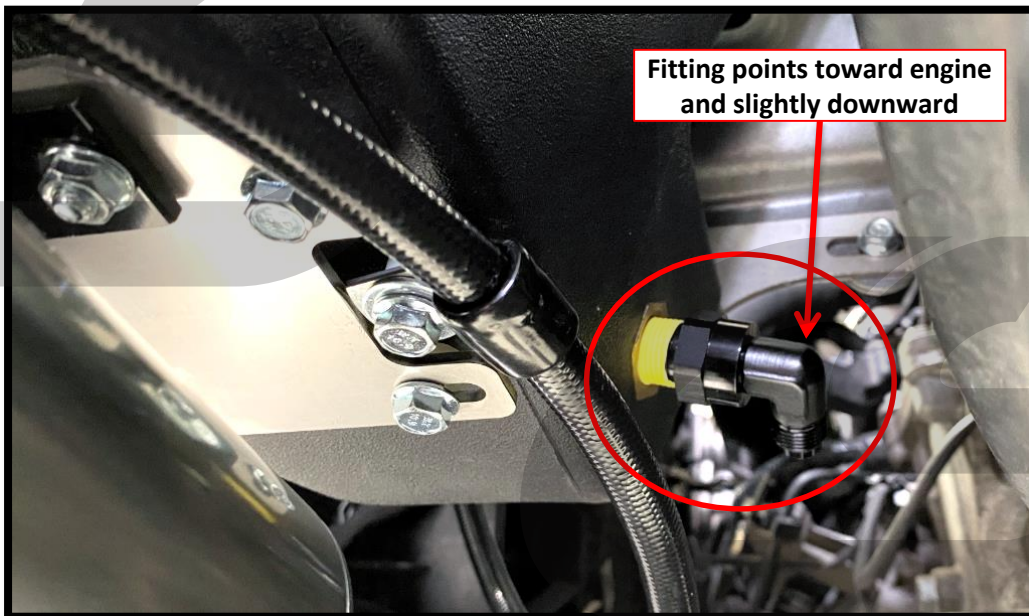

Figure 12k

DETAILED INSTRUCTIONS:

12. Fuel Line Installation (continued)

- q) Locate the final remaining fuel line in your kit. Connect the 90° end to the bottom of the fuel pressure regulator. Shown **circled in red** in **Figure 12l**. Tighten until snug using an 11/16" or adjustable wrench.
- r) Route this fuel line along the first fuel line and connect to the 10258 fitting installed earlier. Tighten until snug using an 11/16" or adjustable wrench. Approximate line routing shown with yellow lines in **Figure 12l** and **Figure 12m**.

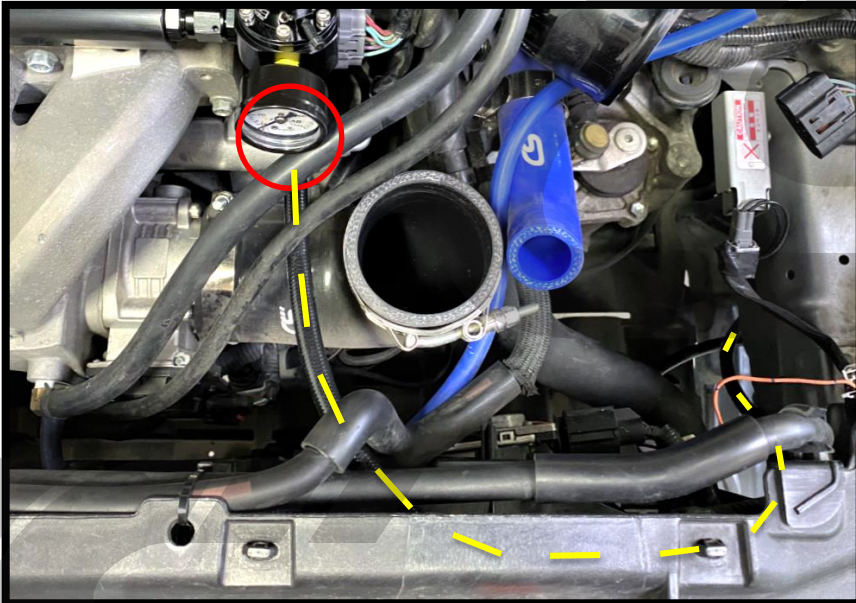

Figure 12l

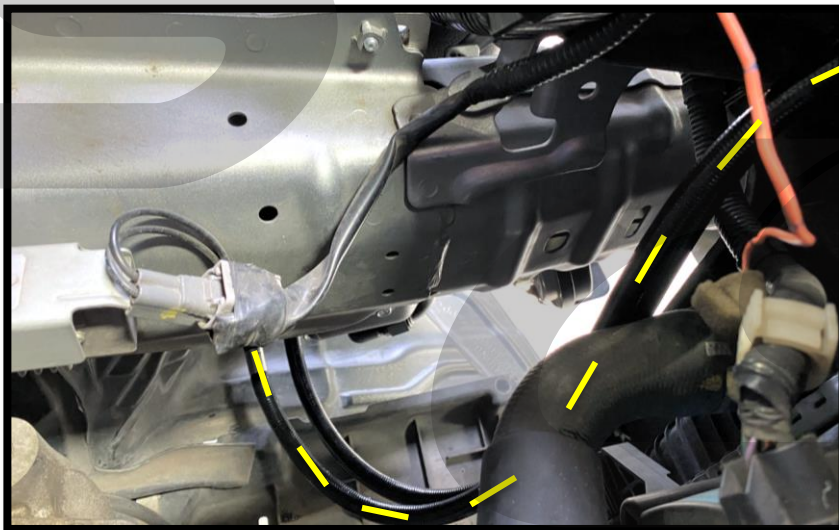

Figure 12m

DETAILED INSTRUCTIONS:

13. Fuel Line Isolation

- a) Locate the OEM hole in the inside of the driver's side frame rail. Shown **circled in red** in **Figure 13a** for GEN1 and shown **circled in blue** in **Figure 13b** for GEN2. This hole will be used to anchor the feed and return fuel lines.



Figure 13a

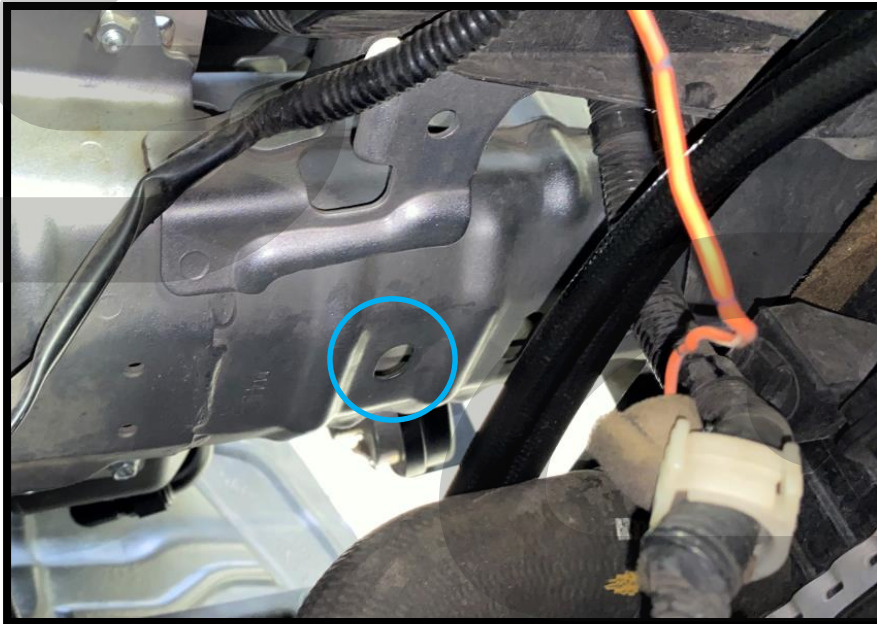

Figure 13b

DETAILED INSTRUCTIONS:

13. Fuel Line Isolation (continued)

- b) Insert the supplied rubber rivet-nut into this hole in the frame rail. GEN1 uses the smaller supplied rivet-nut, GEN2 uses the larger supplied rivet-nut. It will be a snug fit. You may need to angle the rivet nut and use the flexibility of the rubber to get it into position. Shown circled in red in Figure 13c.

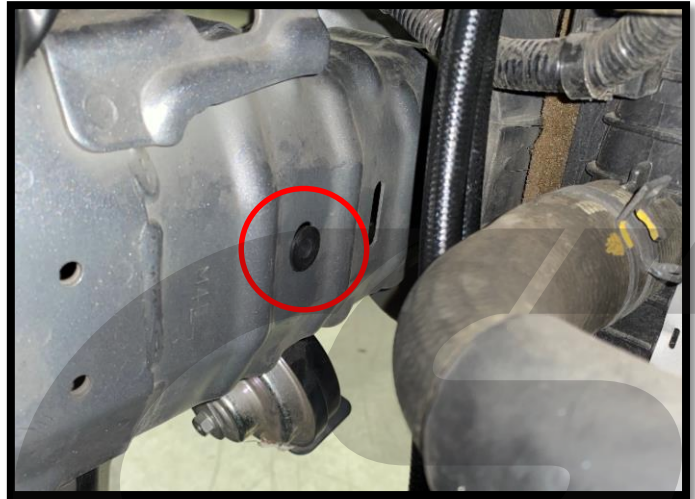

Figure 13c

- c) Figure 13d shows the hardware stack for securing the two lines to the frame rail. Carefully review this hardware setup before moving onto the next step.

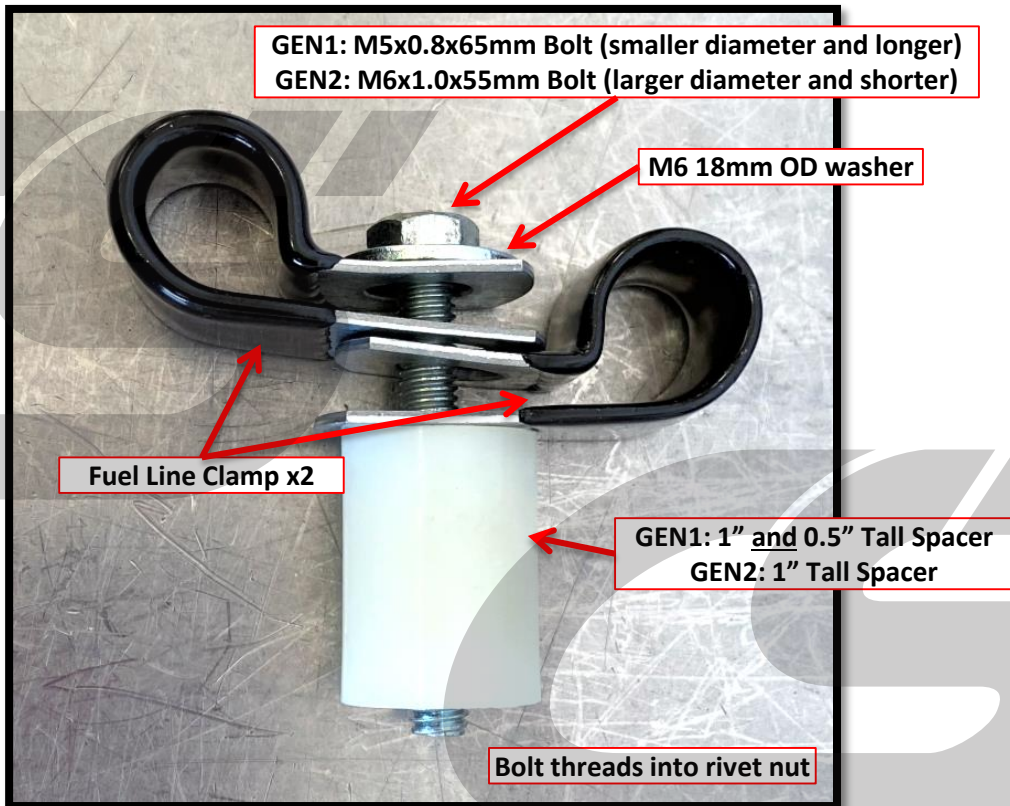

Figure 13d

DETAILED INSTRUCTIONS:

13. Fuel Line Isolation (continued)

- d) Install one fuel line clamp onto each of the fuel lines.
- e) Install the hardware stack as shown in **Figure 13d** into the rubber rivet-nut installed in the frame rail. Do not fully tighten. Shown completed in **Figure 13e** for GEN1. Shown completed in **Figure 13f** for GEN2.



While threading in the center bolt, do not push the rubber rivet-nut all the way into the frame rail. They are very difficult to remove if completely pushed into the frame rail.



Figure 13e

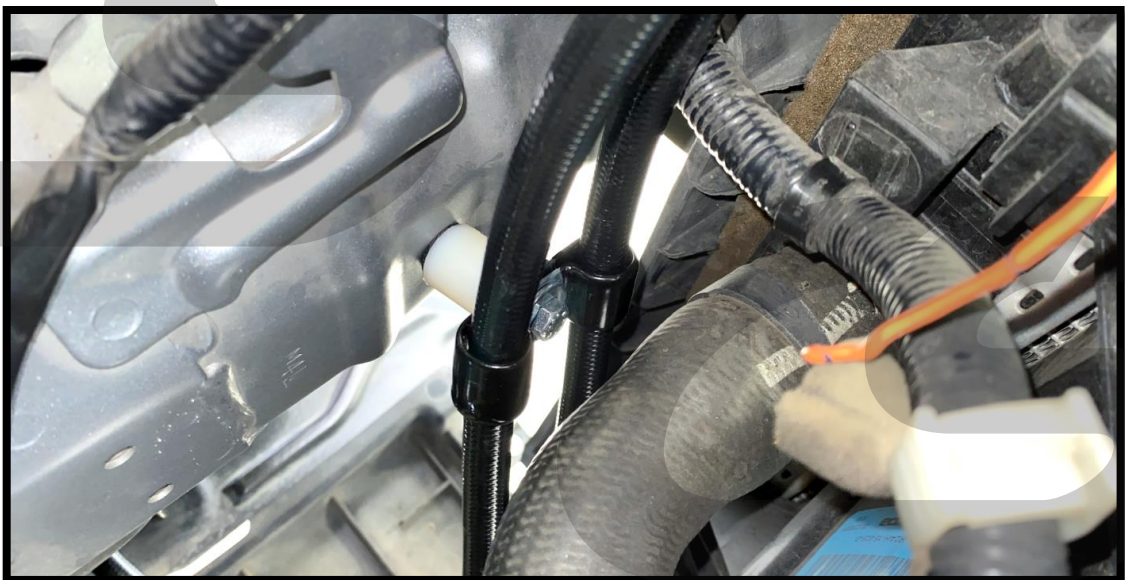

Figure 13f

DETAILED INSTRUCTIONS:

13. Fuel Line Isolation (continued)

- f) Before tightening the center bolt, inspect along the entire length of the fuel lines. Ensure the fuel lines will not rub on any sharp edges. You can adjust the fuel lines by sliding them forward and back within the fuel line clamps.
- g) Once happy with fitment, tighten the center mounting bolt until snug. GEN 1 will use an 8mm socket or wrench, GEN 2 will use a 10mm socket or wrench.



For best fitment, you may need to rotate the fuel line clamps to keep the fuel lines away from any sources of damage.



Depending on your intercooler piping setup, you may not be able to use the exact same mounting method shown in these instructions.

14. Injector & Split Second Wiring Setup



An additional injector controller will need to be used for controlling the PI injectors, unless your vehicle is equipped with an aftermarket standalone ECU. These instructions assume you will be using a Split Second AIC1-V4H (not included with the kit, unless you upgraded to include it)

- a) Each Split Second AIC1-VH4 will come assembled as shown in **Figure 14a**. We will reference the “injector side” and the “vehicle side” of the Split Second wiring harness in later steps.

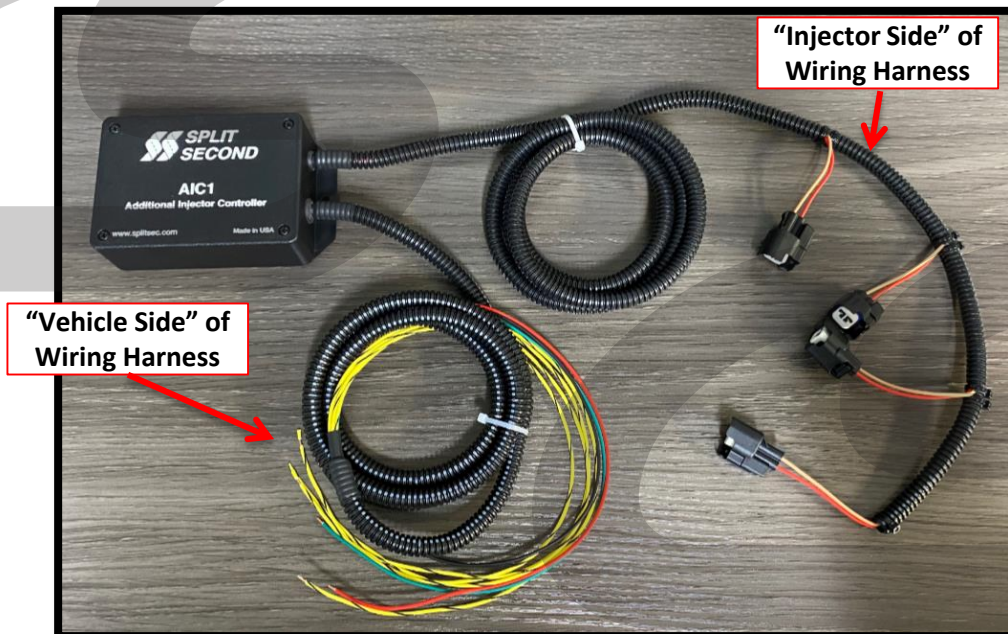

Figure 14a

DETAILED INSTRUCTIONS:

14. Injector & Split Second Wiring Setup (continued)

 **Ensure the battery is disconnected before performing any wiring connections/modifications.**

- b) Begin by mounting your Split Second controller in a safe location in the engine bay. Ensure the location is away from sources of heat and will not get wet.
- c) The "injector side" of the wiring harness is setup and ready to install on your EV6 injectors. Route this harness to the injectors and plug in each injector.
- d) The "vehicle side" of the Split Second harness will need to be connected to your vehicle's wiring harness. Follow the basic wiring diagram shown in **Figure 14b**. Additional information for wiring connections can be seen in **Figure 14c** and **Figure 14d**.



Red Wire: Attach to switched 12V. This is a location that is only powered when the ignition is switched ON. We recommend using the supplied fuse tap in a location in the engine bay fuse box. NOTE: this fuse tap can be shared with switched power for the relay in later steps.



Black Wire: Attach to a chassis ground. Use the ring terminal supplied with the Split Second kit.

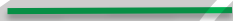

Green Wire: Attach to the **MIDDLE WIRE** that connects to your MAF sensor. Use one of the "T-taps" that come with the Split Second kit. This is the airflow reference for the SS controller.



Yellow & Black Wires: There are four of these wires. One must connect to each of the "trigger" wires of the OEM coil packs (four coil packs, each one gets one yellow & black wire). The trigger wire on each coil pack is the **FAR LEFT WIRE**. Use the "T-taps" that come with the Split Second kit. This gives the Split Second controller RPM reference.

Figure 14b

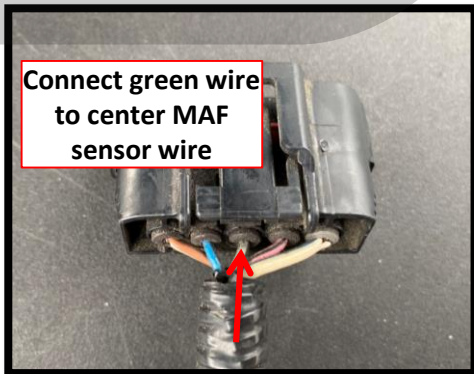

Figure 14c

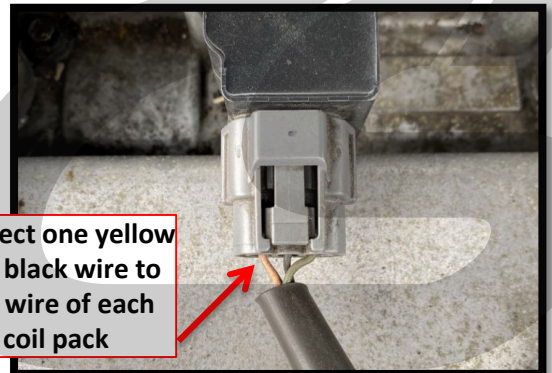

Figure 14d

DETAILED INSTRUCTIONS:

15. Fuel Pump & Misc. Wiring Setup



Additional wiring supplies will be needed for wiring the pump, relay, and Hobbs switches. Ensure you follow the recommended wiring sizes to ensure proper functionality. Reference manufacturer information for further details.

- a) **Begin by opening the AEM relay kit.** Each kit will come with the components shown in **Figure 15a**. We have labeled them for reference in further steps.

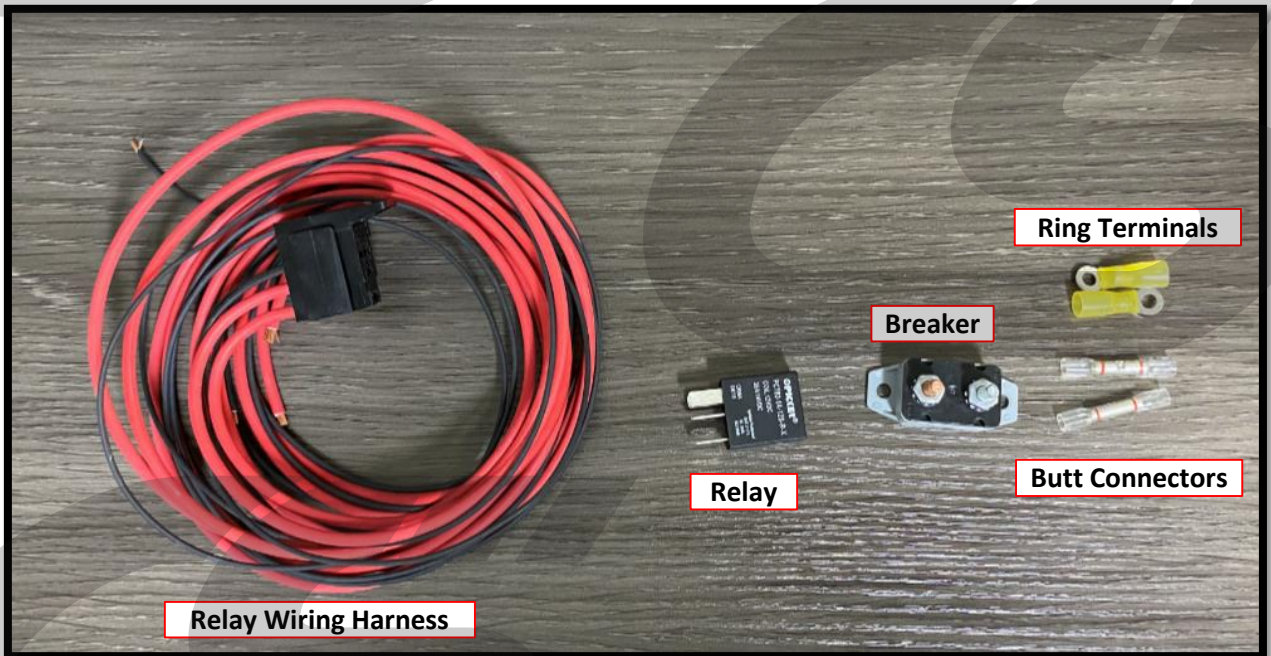

Figure 15a

- b) **Plug the relay into the wiring harness.** It will only install in one direction. Ensure it is fully seated in the harness.

- c) **Figure 15b** shows the numbered terminals of the relay. Use this for future reference.

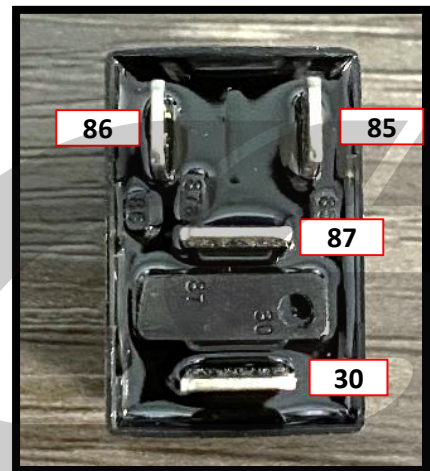

Figure 15b

DETAILED INSTRUCTIONS:

15. Fuel Pump & Misc. Wiring Setup (continued)

d) Find a suitable location for the relay in the engine bay. Ensure it is away from high heat sources and safe from moisture.

NOTE Figure 15c below shows a basic wiring diagram of the entire relay wiring harness. Reference Figure 15c through the next few steps for added clarity.

NOTE Make sure to use the heat shrink on the supplied connectors. We recommend additional heat shrink to further protect against electrical issues.

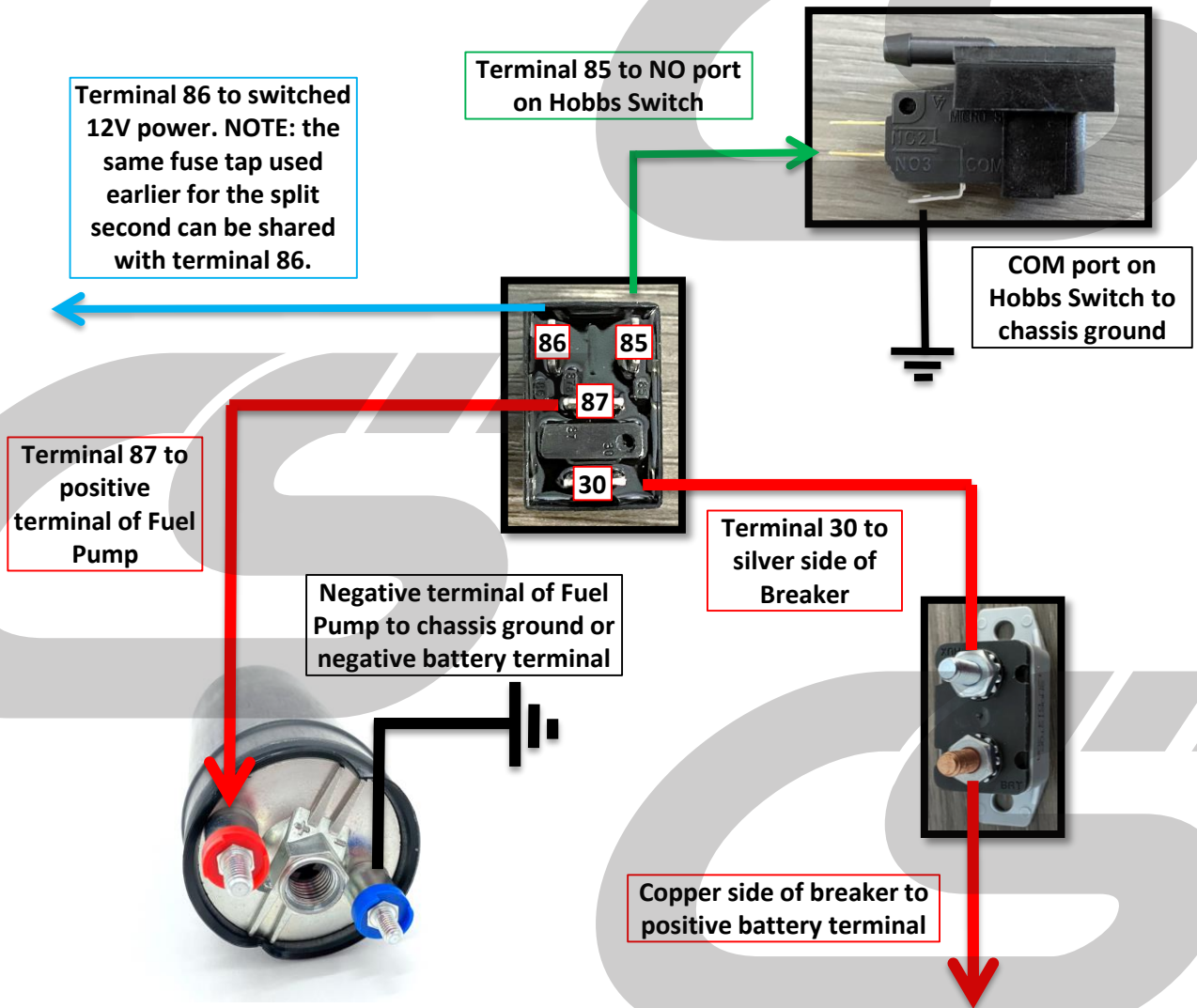

Figure 15c

DETAILED INSTRUCTIONS:

15. Fuel Pump & Misc. Wiring Setup (continued)

- e) **Connect the copper post of the breaker to the positive side of the battery.** Use 10gauge wire for this route. Typically, you can cut some of the red wire from the "30" terminal of the relay. The supplied ring terminals can be used to join the wire to the breaker. Locate the breaker away from sources of heat and moisture. You will need an additional ring terminal to connect to the battery positive.
- f) **Connect the silver post of the breaker to the "30" terminal of the relay.** Again, use the supplied ring terminals and butt connectors. For reference, terminal 30 is the bottom red wire shown in **Figure 15d**. If extra wiring is needed, use 10 gauge wire.
- g) **Connect the "87" terminal to the positive (red) side of the fuel pump.** For reference, terminal 87 is the top red wire shown in **Figure 15d**. If extra wiring is needed, use 10 gauge wire. Use the ring terminal, nut, and weather cover supplied with the fuel pump.
- h) **Connect the negative side of the fuel pump to a chassis ground or the negative side of the battery.** Use 10 gauge wire. Use the ring terminal, nut, and weather cover supplied with the fuel pump.
- i) **Connect the "86" terminal to switched 12V power.** This is a location that is only powered when the ignition is switched ON. For reference, terminal 86 is the left side black wire shown in **Figure 15d**. If extra wiring is needed, use 18 gauge wire.

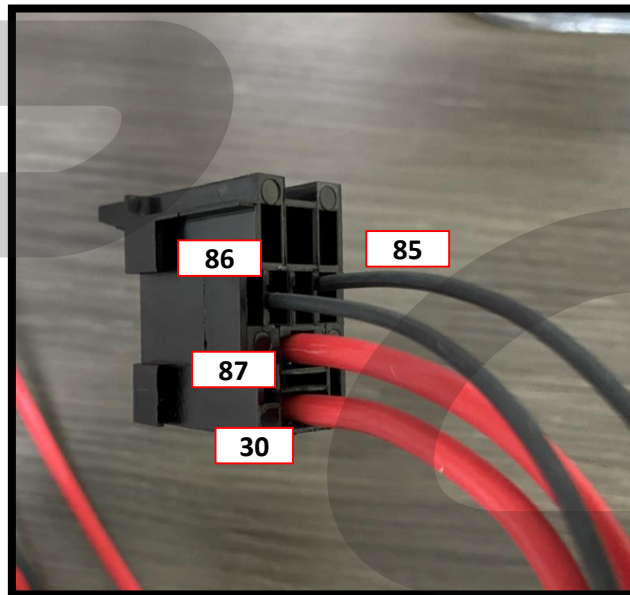

Figure 15d

DETAILED INSTRUCTIONS:

15. Fuel Pump & Misc. Wiring Setup (continued)

j) Locate the Hobbs Switch somewhere easily accessible that is away from sources of heat and moisture. We recommend keeping it accessible for some final fine tuning.

k) Connect the "85" terminal to the "NO" terminal on the Hobbs Switch.. For reference, terminal 85 is the right side black wire shown in **Figure 15d** on the previous page. The NO terminal on the Hobbs switch is labeled in **Figure 15e**. If extra wiring is needed, use 18 gauge wire. You will need some small female spade connectors to connect to the Hobbs switch terminals.

l) Connect the "COM" terminal on the Hobbs Switch to a chassis ground. The COM terminal on the Hobbs switch is labeled in **Figure 15e**. If extra wiring is needed, use 18 gauge wire.

m) Connect a vacuum/boost pressure line from the intake manifold to the port located on the Hobbs Switch that is labeled in **Figure 15e**. Use one of the supplied tee fittings and the supplied vacuum hose to complete this connection.

n) Moving to the level sensor, connect one wire from the low level sensor to ground. It does not matter which wire goes to ground. Use 18 gauge wiring if extra is needed.

o) Locate the supplied LED in a place you can easily see it while driving.

p) Connect the other wire from the low level sensor to the ground (black wire) of the supplied LED. Additional wiring will be required, use 18 gauge. Run the wire through an existing rubber grommet in the firewall.

q) Connect the power wire (red wire) of the supplied LED to a switched 12V power source. Switched power means there is only power going to the circuit when the key is in the on position. Fuse taps are an easy method of gaining switched power.

r) With this setup, the LED will illuminate when there is ~0.8 gallons remaining in the CorkSport aux fuel tank, letting you know it is time to refuel.

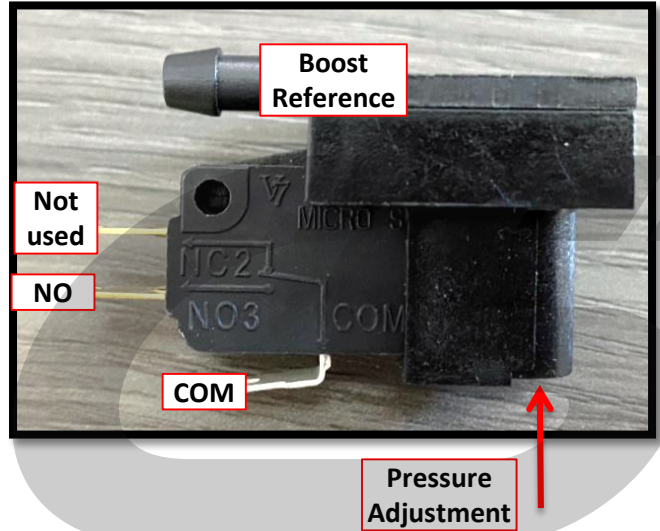

The BPV boost/vacuum reference is a great option to tee into for the Hobbs Switch boost/vacuum reference.

DETAILED INSTRUCTIONS:

16. Final Setup & Testing

- a) **Reconnect your battery terminals and put your car in the key on position.** Without any fluid in the tank, you should see the low level LED illuminated. If no LED is on double check your wiring connections and verify the level sensor is oriented correctly. If the LED is on with the key off, you need to find a proper switched 12V source.
- b) **Fill the CS aux fuel tank with your fuel of choice and verify the low level LED turns off after ~0.8 gallons.** If the light stays on, even after plenty of fuel, double check your wiring connections and verify the level sensor is oriented correctly.
- c) **Test the Hobbs switch is functioning correctly by connecting an air compressor (set to ~15psi) or bike pump to the boost reference line.** Build up a small amount of pressure and you should hear you pump start working.



The Hobbs Switch is set to trigger and turn on your fuel pump at approximately 7psi. You will likely want your Hobbs switch to trigger at a lower psi (~4psi typically works very well). You can adjust the Hobbs switch using a 2mm Allen wrench. Turning the screw counter-clockwise (left) will decrease the pressure the Hobbs will trigger at. The Hobbs switch can be adjusted from ~4psi to ~15psi.



We strongly encourage anyone who is installing this kit to verify their Hobbs switch is triggering at an appropriate pressure, and adjusting accordingly before operating their vehicle. A Hobbs switch that triggers too late can result in lean spikes during spool up which can damage your motor.

- d) **Once your Hobbs switch is set and functioning correctly, apply pressure again to active your fuel pump. Inspect all fittings and connections for fuel leaks.** Note, you can also temporarily connect the NO and COM ports on the Hobbs switch if you don't want to apply pressure to the Hobbs switch.
- e) **With the pump running and pressurizing the fuel rail, the regulator can be adjusted to the correct pressure.** Use a 7/16" wrench to loosen the lock nut, and a 1/8" Allen wrench to adjust the regulator. Clockwise will increase fuel pressure, counter clockwise will decrease fuel pressure. Use the gauge on the regulator as your guide. **Target pressure is 43-45psi with key on, engine off.** Once complete, tighten the lock nut until snug.
- f) **Talk with your tuner to get your Split Second controller calibrated correctly for your setup.** You will need to upload calibrations to the Split Second box using Split Second's software. A serial to USB cable will be needed for this operation.

DETAILED INSTRUCTIONS:

16. Final Setup & Testing (continued)



Before driving your vehicle, it is vital that you get an updated tune for both your Split Second injector controller and your vehicle in general. Adding a PI fuel system will drastically change how the car is fueled and the vehicle will not operate correctly without the correct tune.

- g) For 2007-2009 Mazdaspeed 3, follow Section 1 in reverse to reinstall your headlight, bumper, and any other components removed during installation. All bolts for bumper/headlight/splash shield only need to be tightened until snug.
- h) For 2010-2013 Mazdaspeed 3, follow Section 2 in reverse to reinstall your headlight, bumper, and any other components removed during installation. All bolts for bumper/headlight/splash shield only need to be tightened until snug.
- i) **Carefully monitor your fuel system for the first few weeks its installed. Things to look out for:**
 - Excess rich or lean AFR which may indicate an issue with operation or tune of the fuel system
 - Fuel leaks and/or smells that may indicate a fuel leak.
 - Fluid level in the tank. It may take a while before you understand how long you can go between adding fuel to the system, even with the low level LED. Running out of PI fuel can severely damage your engine if it occurs during WOT.



This completes the installation of your CorkSport Port Injection Fuel System. We recommend close monitoring of the fuel system for the first few weeks to ensure all is functioning correctly. Enjoy the extra fueling and the potential for more power!

WHAT'S NEXT?

CorkSport CST6 Turbocharger

If you're looking for big power for your Mazdaspeed without the headache of non-OE style fitment, then you have come to the right place. The CorkSport CST6 owns the Mazdaspeed Stock Flange Turbine Record at 684whp all while using stock flange components.

Years of R&D have allowed us to design a high-performance turbocharger that can respond quickly, support 600+whp, and perform with stock style turbine flanges. The CST6 features a Garrett CHRA with a Ceramic Dual Ball Bearing Cartridge for improved response and durability for high boost applications. Testing has pushed the CST6 to 38psi maxing out an auxiliary fuel system flowing 40gph of methanol.



CorkSport 13" Big Brake Kit

The Stage 2 CorkSport 13" Big Brake Kit for Mazdaspeed 3 provides a drastic improvement to braking by offering improvements to each component in the system.

Larger rotors, 4-piston calipers, stainless steel brake lines, upgraded pads, and everything you need to install on your Speed 3 is included in this kit. If the CorkSport Big Brake Caliper Kit was not enough for you and your MS3, look no further than the CorkSport 13" BBK.



CorkSport Intake Manifold

Reintroducing the CorkSport Intake Manifold V2 for the DISI-MZR engine found in the Mazdaspeed 3 and Mazdaspeed 6. First impressions will quickly tell you this is a very different design and design goal than typically found in the performance aftermarket options for the MS3 and MS6; that's for good reason. The CorkSport Intake Manifold takes performance and OE fitment and combines them to create a combination that performs and fits without compromise. Equal flow, higher flow, tighter packaging, auxiliary fueling support, and TMIC fitment are aspects that define the CorkSport Intake Manifold.

